

AK550 Premium

SCOOTER

E5

OWNER'S MANUAL



Dear users:

Thank you very much for purchasing our **AK550 Premium E5** product.

This Manual gives detailed instructions on how to operate, maintain and adjust the **AK550 Premium E5** for prolonged durability and comfort. This model of vehicles complies with EPA regulations on scooter emission control standards, therefore complying environmental requirements in terms of low pollution, low noise and low energy consumption. Although having exceptional quality, regular maintenance is still essential for keeping the product in giving optimal performances.

In order to enjoy a safe and comfortable journey with your motorcycle, please read this manual thoroughly.

CONTENTS

PRECAUTIONS ON SAFE DRIVING	1	Electric Windshield adjuster	42
Engine Number	5	Horn Switch	42
Frame Number	6	Rear Brake Lever	43
Mark Drive Caution	6	Front Brake Lever	44
Left View of Scooter	9	Parking Brake Arm	45
Right View of Scooter	10	Storage Box	46
Left handlebar functions	11	Electric Windshield	48
Right handlebar functions	12	Rear View Mirror	50
Center Multifunction Switches	13	12V Power Socket	50
LCD Dashboard Function	15	Main Stand	52
HOW TO ENTER THE NOODOE SYSTEM	20	Fuel Filler Cap	53
KEYLESS CAR KEY	27	TPMS, ELECTRONIC TIRE PRESSURE SENSOR	54
KEYLESS SENSING DISTANCE	29	TPMS Learn Code Operation	55
Short-range sensor	30	TPMS abnormal status	57
KEYLESS Main Switch	32	ABS (ANTI-LOCK BRAKING SYSTEM)	58
STEERING STEM LOCK	34	TCS	62
MAIN SWITCH FUNCTIONS	35	AIBS	63
1. Park Alert Switch	36	O2 SENSOR	63
2. Meter Change Button	36	Muffler and Catalytic Converter	63
3. noodoe Enter / Change Button	36	STARTING THE ENGINE	65
4. noodoe Pgup (↖) / Pgdn (↘) button	36	Proper Riding Method	67
5. noodoe Change Button	36	Release Front and Rear Brake Levers	68
Engine Ignition Button	36	Brakes	69
CRUISE CONTROL SETTINGS	40	Proper Parking Method	70
Blinker Switch	42	Checks before Riding	73
Headlight switch	42	Engine Oil and Oil Filter	73
High / Low Beam and Passing Light Switch	42	Check / Replenish Engine Oil	73

Using Fuel Tank Cap.....	75
Inspection of front / rear brake oil	77
Front / rear brake oil replenishing.....	77
Check Front / Rear Brake Lining	78
Check Tires	78
Check the Brake Light	80
Check the Tail Light.....	80
Turn on the KEYLESS main switch power.	80
Check if the Tail Light goes on.	80
Check the Tail Light Lens for stain or fracture.	80
Check the Headlight	81
Turn on the KEYLESS main switch power.	81
Turn on ignition of the engine.	81
Check if the Headlight goes on.....	81
Check the Headlight Lens for stain or fracture.....	81
Check Winkers	81
Turn on the KEYLESS main switch power.	81
Check Front / Rear Cushion	82
Inspect the outer transmission belt.....	83
SIDE STAND.....	84
INITIAL CHECK.....	84
PRECAUTIONS.....	84
OVERVIEW OF REGULAR MAINTENANCE	85
Check Battery.....	87
Check battery voltage:.....	87
Method of replacement.....	87

Fuse Replacement.....	90
Fuses Specification.....	90
Air Filter	91
Replace Filter Wool.....	92
Change Oil.....	93
Oil Change Period.....	93
Spark Plug Check and Adjustment	96
Cleaning Method.....	96
Adjustment.....	96
Check Coolant	97
Exhaust Emission Control System:.....	101
SPECIFICATIONS	104

MEMO

Precautions on Safe Driving

- Peruse user manual and precautions.
- Driver shall wear a helmet, gloves, goggles, etc.
- Do not wear clothes that may impede safe driving.
- Excessively wide and loose sleeves may be caught by the brake lever and is extremely dangerous.
- Operation of brake lever shall in no case be obstructed.
- Daily and regular checks are necessities.
- Visually check tire appearance for any foreign object or unusual abrasion.
- Exhaust gas from the muffler contains carbon monoxide which is harmful to human body.
- Start the engine only in a well-ventilated location.
- Buckle up chin-belt when wearing a Helmet.
- Hold the Handlebar with both hands when riding. Do not ride by single hand for this is extremely dangerous.
- Wearing flat shoes is safer.
- The muffler is at a very high temperature after stopping the running engine, do not touch it.
- Avoid dry grasses or flammables when parking the motorcycle, for the prevention of fire risks.

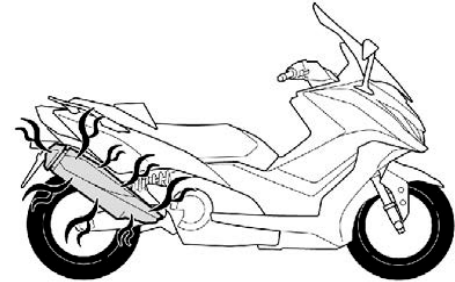

- The muffler is at a very high temperature after stopping the engine; park the motorcycle with the Muffler facing a wall or a location free of pedestrian, for preventing any burn hazards.
- Metal or plastic parts of the scooter may reach a very high temperature after exposing to sunshine; care shall be taken not to touch such surfaces or a burn may occur.
 1. Avoid making sharp turns or one-handed driving.
 2. Abide by all traffic rules.
 3. Smoking is prohibited when replenishing fuel.
 4. Stop engine when filling with fuel.
- When mounting/dismounting the scooter, special care must be taken by the rear rider to prevent being burnt

Precautions on Safe Driving

by the high-temp Exhaust Pipe.

- Operability of the handle varies in conditions with or without an extra load.
- Do not let children or persons unfamiliar with the vehicle operate it.
- Do not hand over the vehicle to persons unfamiliar with the operation of the vehicle.



- When riding the motorcycle, the rider must place both feet on the pedals; the rear rider shall put arms around the rider's waist and both feet on the rear pedals.
- Avoid overloading when carrying objects. Make sure that objects are fixed properly. Extra care must be taken for safe driving.
- Vehicle functionalities are related to its structure;

arbitrary modification may deteriorate operability of vehicle, causing shortened service life and obstructed driver safety.

- Arbitrary modification of a vehicle is an illegal action forbidden by law. Never try to make any modification.
- Modification of vehicle may result in a nullified warranty.
- Do not go near or touch the belt or front/rear wheels while they are in motion to avoid danger.

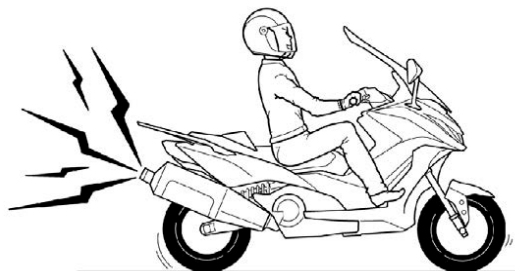

- Natural mental relaxation and comfortable clothes are essentials to a safe driving.
- Abide by traffic rules, avoid anxiety, relax your mood, and pay attention to drive.
- Avoid wearing clothes that may impede driving safety when riding the scooter. (E.g., long skirt, flared trousers, etc.)

- The exhaust pipe is under extremely high temperature when riding the motorcycle or after the journey. Keep any portion of the body from touching the exhaust pipe to avoid scalding injury.
- Avoid dry grasses or flammables when parking the vehicle, for the prevention of fire risks



Warning

Do not turn on the ignition and begin its related operations when the vehicle's main stand has not been erected, especially for children, the elderly, and persons unfamiliar with the characteristics of the vehicle. The owner of the vehicle is responsible for checking these relevant safety control measures.

The maximum load of the storage box shall be limited to 10kg at most.

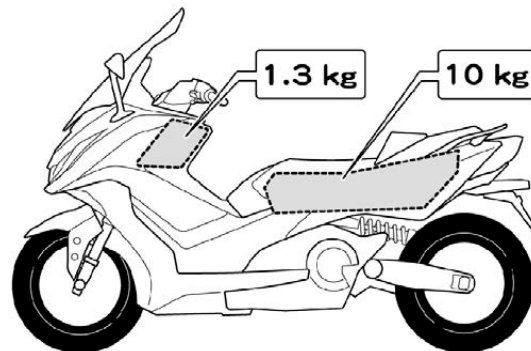

Do Not exceed the following load limits:

The maximum load of the front storage box shall be limited to 1.3 kg at most.

The maximum load of the storage box shall be limited to 10 kg at most.

Precautions on Safe Driving

It is forbidden to install a carrying basket or bracket on the front header. Carrying anything in front of the vehicle will surely block the headlight and significantly affect driving safety.

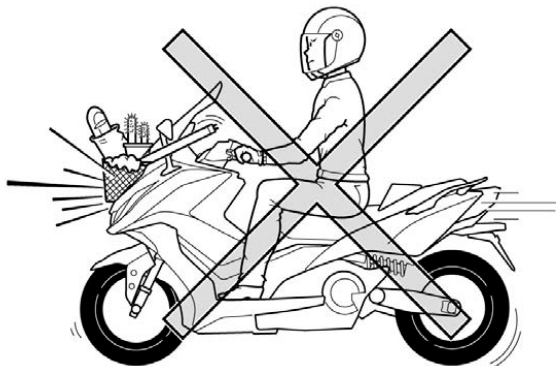

Owner Information

ID Number Record Field

Please note down the Engine Number and Vehicle Frame Number in the relevant fields below to facilitate ordering spare parts from a KYMCO dealer, or for reference in the event of a lost of vehicle.

ID Number Record Field:

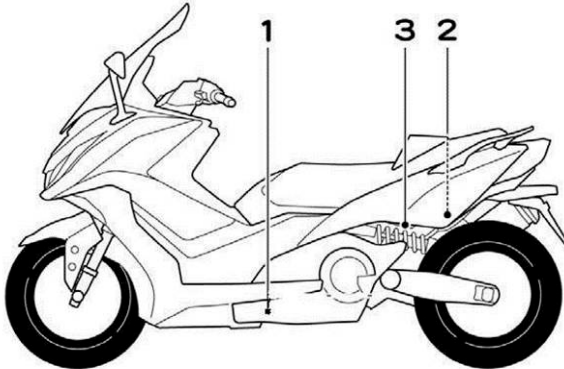

The Engine Number is engraved on the crank box as shown in the figure.

- 1: Engine number engraving. 2: Frame number engraving.
3: VIN Aluminum nameplate.

Engine Number



The Engine Number is engraved on the crank box as shown in the figure.

Frame Number

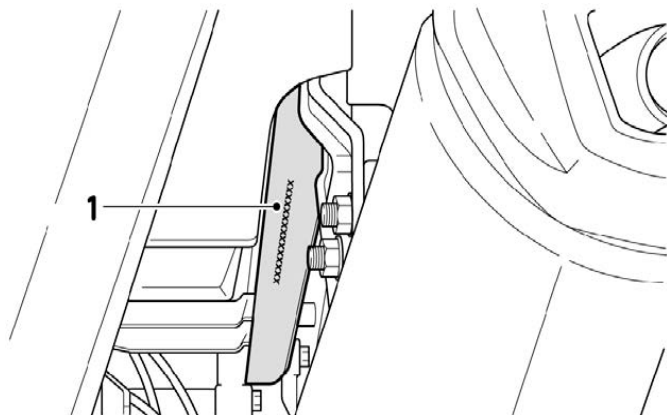

Frame Number Imprint

Engrave the number onto the frame indicated in the drawing. The Frame Number can be seen from lower-right upwards.

Mark Drive Caution

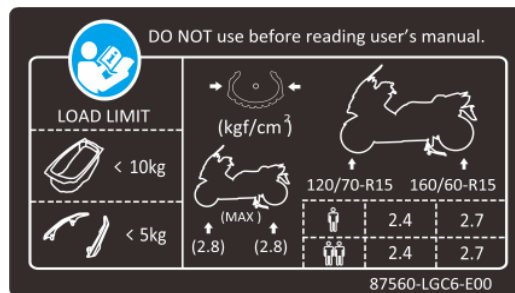

The mark drive caution and label fuel tank of the motorcycle is tagged on the backside of the box, luggage of the scooter .

Collection of motorcycle data record

The ECU of this model collects and records the information on motorcycle to assist in fault diagnosis and troubleshooting.

To acquire the information, it is required to connect the Kymco diagnosis tool to the diagnosis connector of the motorcycle (e.g. maintenance check or repair).

Refer to the figure on the right.

The sensor and recorded information depend on the Kymco model. However, the main information available is as follows:

- 1.Information on motorcycle status and engine performance.
- 2.Information on motorcycle injection and emission.

Kymco will not disclose this information to a third party except for the following conditions:

- 1.Kymco has acquired the approval of the user and owner of the vehicle.
- 2.The law requires Kymco to provide such information.
- 3.Kymco must submit the information to the court for litigation.
- 4.Kymco must provide such information for research

purposes and this information is not related to a specific motorcycle or owner.

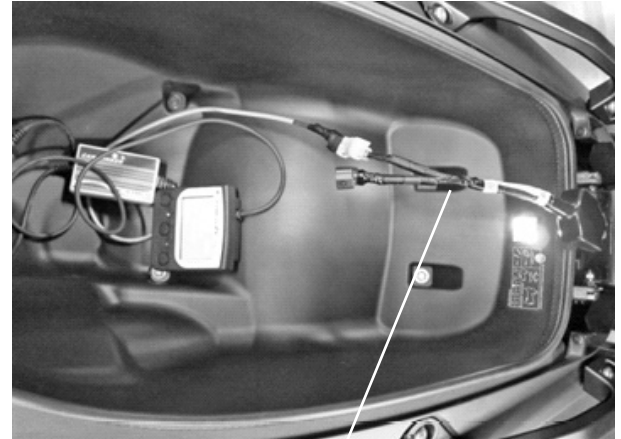

Diagnosis connector

MEMO

Parts Names
Left View of Scooter

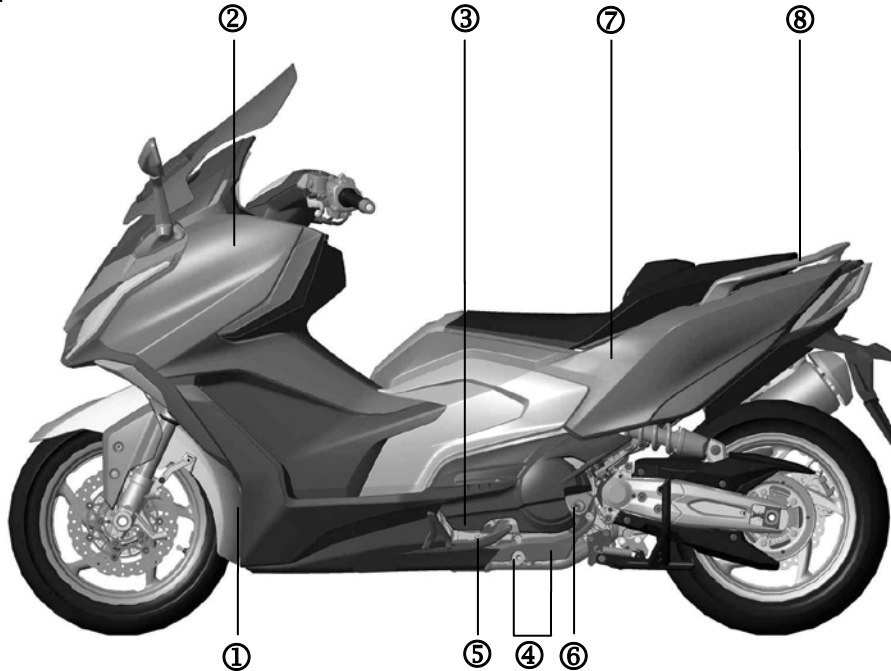

1. Coolant Checking Window

2. Battery

3. Engine Oil Filter

4. Engine Oil Drain Bolt

5. Left Foot Bar

6. Oil level guide

7. Storage Box

8. Left-rear Handlebar

Right View of Scooter

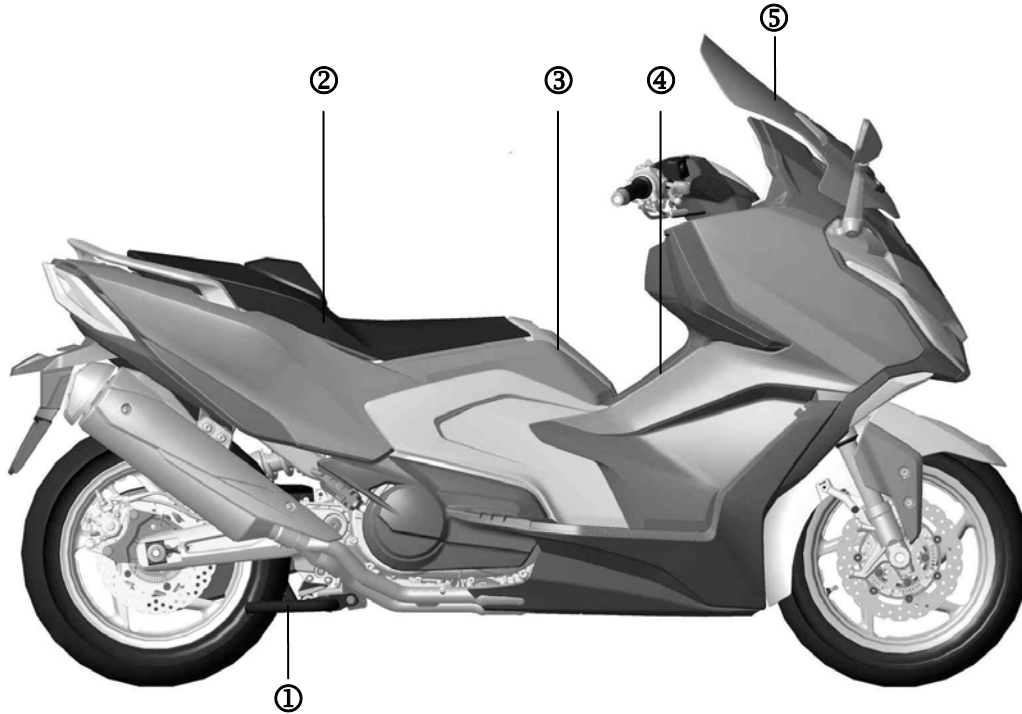

1.Main Stand

2.Tool kit

3.Fuel Tank

4.Air Cleaner

5.Electric Windshield

Left handlebar functions

(front)



1. Handlebar Heater Indicator
2. Set/decelerate button (-)
3. Reset/accelerate button (+)
4. Cruise setting key
5. Winker Switch
6. Headlight Switch
7. High/Low Beam and Passing Switch
8. Electric Windshield Adjust button
9. Horn Switch

(rear)

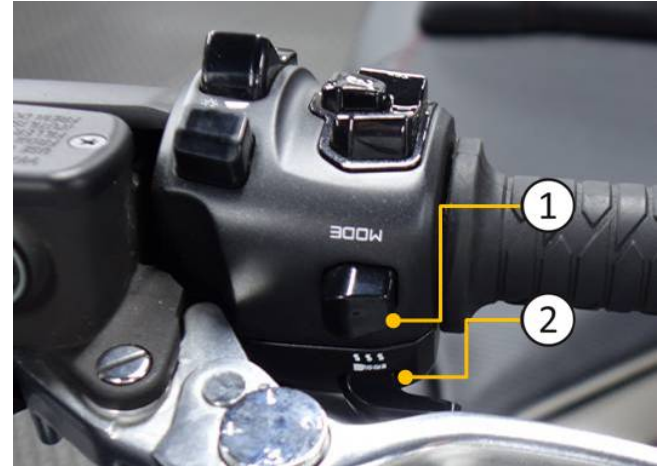

1. Normal / Rain / TCS mode switch
2. Handlebar heating button

Right handlebar functions

(front)



1. Park Alert Switch
2. Dashboard Selection Button
3. Noodoe Enter / Change Button
4. Noodoe Pgup / Pgdn Button
5. Noodoe Selection Button
6. Engine Ignition Button

(rear)



1. Release Engine Stop Switch
2. Engine Stop Switch

Center Multifunction Switches



1. Fuel Tank Cap Switch
2. Storage box switch
3. Odometer Switch: Switch between TRIP A and B
4. Steering Stem Lock: Used to lock the steering stem

Main Switch



MEMO

Control Functions of Mechanism

LCD Dashboard Function

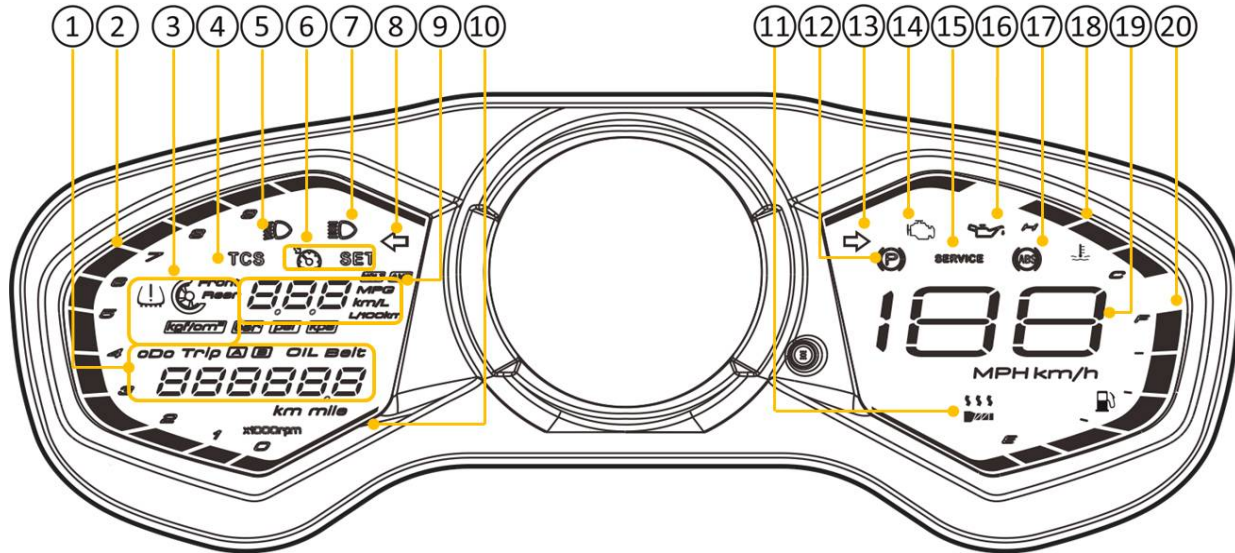









1. ODO/TRIP A,B	2. Tachometer	3. Tire Pressure Indicator	4. TCSI indicator	5. Low beam	6. Cruise control
7. High beam	8. Left winker	9. Instant fuel consumption display	10. Power/Rain mode	11. Heating the Handlebar	12. Parking brake indicator
13. Right winker	14. Engine failure indicator	15. Engine oil replace indicator	16. Engine oil pressure indicator	17. ABS warning indicator	18. Water temperature warning indicator
19. Speedometer	20. Fuel gauge				

1. Mileage Information:

- Km/Mile Unit Change-over: When in ODO Display Interface, Press-and-hold "O" button on Right Handlebar Switch for 2s to switch-over between Km and Mile display.
- Pressing DOWN () button on the Right Handlebar Switch, ODO → TRIP A → TRIP B → OIL → Belt
- ODO → Total running Mileage displayed in Km or Mile.
- TRIP A/TRIP B → Single trip mileage; Single trip mileage can be zeroed by pressing and holding "O" button for 2s.
- OIL → Oil Service Mileage. After running 5,000km, the "services" symbol on the right of Dashboard lights up constantly, indicating an oil recheck is required.
- Belt → Belt Service Mileage. After running 20,000km, the "services" symbol on the right side of the Dashboard will light up constantly, indicating a CVT belt replacement is required.

**Caution**

- Oil Replacement indicator will only light up after running 5000km, therefore it will not light up for the first oil replacement at 1000km. However, a Zero adjustment is still necessary after oil replacement at 1000km so that the indicator can act correctly for a subsequent indication.
- When the accumulated mileage reaches 5000 km, the oil change indicator (service symbol) will light up. Switch to OIL mode and reset the accumulated mileage to 0. The oil change indicator (services symbol) will turn off, and the mileage will begin recounting from 0.
- When the accumulated mileage reaches 20,000 km, the belt change indicator (service symbol) will light up. To reset, switch to Belt mode and reset the accumulated mileage to 0. The belt change indicator (service symbol) will turn off, and the mileage will begin recounting from 0.

2. Tachometer: Indicates engine speed in rpm; each scale multiplied by 1000rpm.
3.  Tire Pressure Detection Indicator: After KEY ON, this indicator lights up if tire pressure is too high or too low. If tire pressure decreases rapidly, the indicator flashes quickly; if tire pressure decreases slowly, the indicator flashes slowly.
 - Change unit of tire pressure: When in Tire Pressure Display Interface, click "O" button on Right Handlebar Switch to switch-over units in the sequence of "kg/cm² → bar → 14psi → kpa".
4. TCS indicator light will light up in amber color when turn on the ignition switch. Once the vehicle speed over 6 km/h, the indicator light will go off automatically. The TCS keeps function at this time.
5.  Low beam: Pushing the switch to "" for Low Beam.
6.  Cruise control: This function is the settings for cruise control, please refer to "Settings for Cruise Control".
 -  Settings button: This is the settings button for cruise control.
 7.  High beam: When this indicator lit, the headlight is in the high beam position.
 8.  Left blinker: Direction button for left turn, indicator light will flash when turned on; press middle button to turn off.
 9. Instant fuel consumption display: The instantaneous fuel consumption is calculated for display reference according to the throttle openness. There are three fuel consumption unit selections of km/L, L/100 km, and MPG. They must be set on the right handlebar switch. (When TRIP A is reset, the average fuel consumption will also reset.)
 - When clicking UP () button on the Right Handlebar Switch, VOLT(Battery Voltage) → AVE (Average Fuel Consumption) → (Instant Fuel Consumption) → TPS(Tire Pressure)
 - VOLT → Indicates Battery Voltage
 - AVE → Average Fuel Consumption(AVE) mode, indicates Average Fuel Consumption(km/L and L/100km), (after returning TRIP to Zero, AVE will

Control Functions of Mechanism

also return to Zero.)

- → Instant Fuel Consumption Mode, AVE indicator goes off, indicating Instant Fuel Consumption of vehicle (in km/ L and L/100km).
- Change unit of fuel consumption: When in AVE/Instant Fuel Consumption Mode, Click "O" button on Right Handlebar Switch to switch-over between "km/L" and "L/100km".



Caution

- When selecting Mile Gauge, the displayed unit is MPG, i.e. miles per gallon.
- The Average Fuel Consumption or Instant Fuel Consumption of the vehicle displayed by the meter is for reference only. The actual fuel consumption is dependent on the actual vehicle behavior. For your safety concern, the AVE should be checked after the vehicle is stopping riding.
- When Battery Indication is lower than 12V, it means the battery power is low and an immediate check-up or re-charge is required.

10. Power / Rain / TCS Off mode: The MODE button is located among the left handlebar switches, and can be

switched between Power/Rain/TCS Off modes depending on the driver's need.

11.  Heating the Handlebar: Refer to "Heating the Handlebar".

After turning ON the Main Switch, press and hold Handlebar Heater Button for 3s or more to activate/deactivate Handlebar Heating Function. Refer to "Heating the Handlebar".



Handlebar Heater button

12.  Parking brake indicator: When this light is lit, the parking brake is locked.

13.  Right blinker: Use this position for Right Turn.

14.  Engine inspection indicator: After "KEY ON," the engine inspection indicator will illuminate and then extinguish by itself after starting the engine. In this case, it means the vehicle is under normal conditions.

If the indicator is persistently lit, it means there are problems in the vehicle system. Please visit the service station for inspection and maintenance.

15.  Oil/belt service indicator: OIL → Oil change indicator. When the vehicle reaches 5,000 km, the services symbol on the right side of the dashboard will stay lit, indicating that oil needs to be checked.

Belt→Belt Replacement Indicator. After running 20000km, the “services” symbol on the right of Dashboard lights up constantly, indicating a CVT belt replacement is required.

16.  The Oil Pressure Warning Indicator: The Oil Pressure Warning Indicator lights up when KEYLESS Main Switch is activated. The Oil Pressure Warning Indicator will go off when the engine is started. The Oil Pressure Warning Indicator will light up if the oil pressure is lower than normal action when the engine rotates. This denotes a system anomaly; you need to go to a KYMCO dealer for a check-up.

17.  ABS warning indicator: The light should be turned off during travelling, indicating the ABS braking system is in operation. If the light stays lit during

travelling, and cannot be resolved, please visit the dealer shop for repairs.

18.  Water temperature warning indicator: When riding, if the water temperature reaches H (high temperature), it means the water temperature is faulty. Please park the vehicle in a safe location, turn off the ignition, wait for the temperature to drop, check and refill the coolant, then restart the engine, and visit the KYMCO dealer shop for inspection or repairs immediately. The user should take extra care, riding forcibly when water temperature is at H (high temperature) may cause engine failures.

19. Speedometer: In the ODO mode, pressing the MODE and RESET buttons simultaneously more than 2 seconds to shift mile and km unit display. When switching the setting, all units used in the dashboard will be switched simultaneously. (except that of tire pressure)

20. Fuel gauge: The fuel gauge is divided into five sections.

How to enter the noodoe System

- Step 1: Download the app. Refer to "Download noodoe app", download the app and the system installs the app automatically.
- Step 2: For detailed operation of the button, please refer to "Introduction of Right Handlebar Switch Operation Button".
- Step 3: Refer to "Scooter Pairing" and creation upload for scooter pairing.

noodoe Function

- A. Refer to "Introduction of App Function/Create Mode" for an introduction of app functions.
- B. Refer to "Find My Scooter" for locating scooters.
- C. Refer to "Message Notice" for the message notice function.
- D. Refer to "Welcome Light" for the welcome light function.

Enter the noodoe Function

- Step 1: Download the app. Refer to "Download noodoe app", download the app and the system installs the app automatically.
- The user may enter the Google Play Shop (Android) or App Store (iOS) and search "noodoe."





Caution

Minimum supported version: Android 6.0 or above, iOS 12.1 or above.
You cannot run the app if your phone doesn't support Google service.



Step 2: Introduction to operation buttons



	() Button → Up Button
	() Button → Down Button
	(O) Button → Enter Button

While Driving



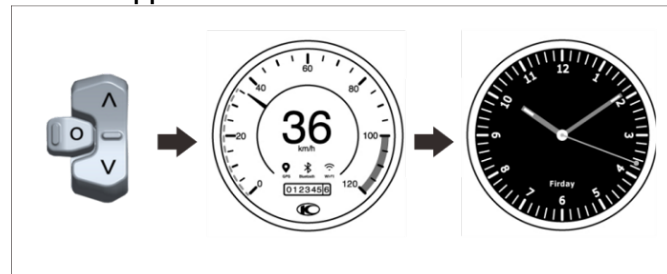

- Operate () and () buttons to switch-over between 4 screens of Dashboard noodoe functions.
- Press (O) button to end the action.

When Stopped:



Message Notice:

- Operate () and () buttons to switch-over message notices in the Dashboard noodoe Function. Press the (O) button to activate or close message notices.

Step 3: Scooter Pairing

To use Scooter Pairing, the user needs to enter the APP (cell phone) → set up (cell phone) → Scooter Setting → KEY ON (Scooter) → Select a new user or an existing user (Scooter) by the Operation Button → Press (O) button to enter “Pairing Mode” (Scooter) → Select Bluetooth Device (cell phone) → Link (cell phone) → Confirm Code (cell phone and Scooter) → Press (O) button → Pairing accomplished.



Uplinking creation

User created Dashboard can be installed onto scooter.

Cell phone display

Dashboard display

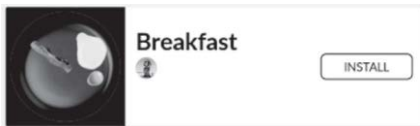

noodoe Function

A. Introduction app functions

- The user may browse and collect creations from users all over the world and install them into the Dashboard of your scooter.
- The user may collect or remix any creation they find, or design their own Dashboard in Create Mode.

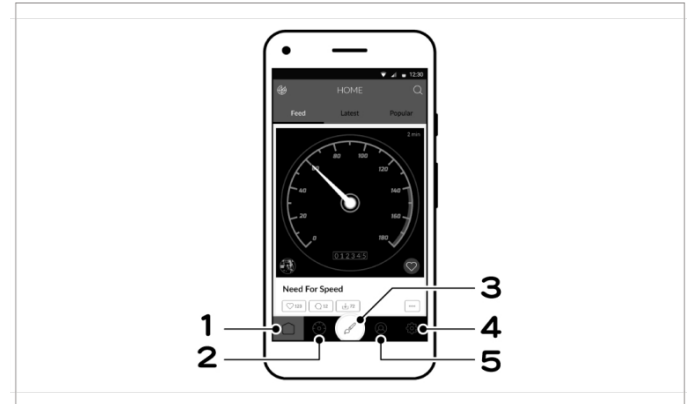

1 : Home/Feed 2 : My Dashboardes

3 : Create Mode 4 : My Profile 5 : Settings

Create Mode

Create Mode allows you to remix an existing template to your liking

Pick between Clock, Weather, Compass or Speed and unleash your creativity. You can change colors, fonts, upload your own images and more.

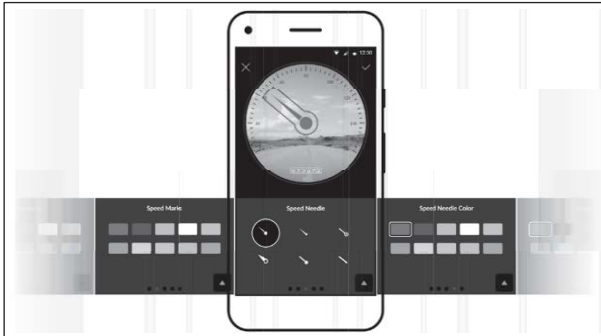

B. Find My Scooter

- Forgot where you've parked? No worries, noodoe remembers. Tap the  icon and the app will guide you back to where you last parked.
- Find your scooter either on the map or by following the directions from the app, complete with distance and direction.



Open the Bluetooth and the online function of the handset. The vehicle search function is designed with the following two display modes:

1. Map Mode
2. Azimuth Mode

C. Message Notice

- Once the cell phone is linked, any incoming message will be forwarded to the scooter dashboard.
- (Android users may select their display with → Setting → Application).

While Driving:



A message "For the sake of safety, no message is viewable when you drive the scooter." is displayed on the top of the noodoe Dashboard.

When Stopped:



Any message received during your ride will be displayed automatically when you make a subsequent stop. You may also press the ENTER button on the right handlebar switch (only when your stop the scooter) to manually search message contents.

D. Welcome Light

When searching for your motorcycle in a congested parking lot or during night hours, open the APP with the handset and then push "Find My Scooter". After that, it will light up the "Welcome" indicator to help you identify and find your scooter. It is a function designed for practical use.



Warning

- When using the noodoe function, make sure that the batteries of both the cell phone and scooter are fully charged. If you need to start the engine for charging, do it in a well-ventilated place.
- If the battery voltage is too low when shutting down the power, the "noodoe system" will turn off the

Bluetooth/Online/Welcome function automatically. If the battery is still inactive after starting the engine, please contact your dealer for repair services.

- To conserve energy, the welcome light will turn off after 2 minutes.



Caution

- For enhancing accuracy of displayed weather and local information, you should activate GPS and Network functions of your cell phone. (In case of cell phone signal failure, previous information will be displayed until resumption of cell phone signal for displaying accurate information).
- Switching over of Speed / Temperature / Time units is carried out from the cell phone; minor differences resulting from the frequency of data updating is within a reasonable range.
- Scanning speed and results of Bluetooth Device may be limited in compatibility issues due to cell phone specifications.
 - a. Scanning speed of Bluetooth Device is slow.
 - b. Pairing is unsuccessful.
 - c. Bluetooth error occurs during the link.

- The User needs to set the cell phone's Cloud Messaging function to facilitate noodoe message display.
- While driving, noodoe will not display any message (including incoming call, message, LINE, FB, etc.). When the vehicle stops, noodoe automatically displays incoming calls and relevant information.
- The last screen at the previous shut down will be the first screen on a restart.
- The compass function must be activated by performing setup on a cell phone. Minor errors may exist depending on data update frequency.
- The compass only performs self-verification to modify orientation when the vehicle starts to move, therefore it is normal that no orientation calibration is activated after connecting the noodoe App while the vehicle has not yet started moving.
- Time in noodoe will be calibrated automatically after connecting noodoe with a cell phone.
- The user shall never operate noodoe while riding the vehicle or an accident may occur.
- The action of the Welcome Light function can be set using an app (enabled or disabled).
- When Welcome Light is set to enabled:

Control Functions of Mechanism

- a. The Welcome Light is only activated on a subsequent connection of a Bluetooth Device. Each activation lasts for 2 minutes before switching off automatically.
 - b. After each ride, a single cell phone linkage will only activate the Welcome Light 3 times; the Welcome Light will shut off Bluetooth functions automatically after being activated 3 times.
 - c. Entering the Find My Scooter screen will cover functions a and b, in which case the system enables the Welcome Light until the user gets out of Bluetooth range or disables the Bluetooth connection function.
 - d. After the "Welcome" indicator extinguishes, it will maintain standby status for 1–3 days (allowing you to execute the setting in the APP). If the standby duration expires or if the battery voltage is too low (about 12V), the Bluetooth function will shut down automatically.
- When the KEYLESS Main Switch is OFF, all the information will be removed, to prevent the leaking of personal info.
 - App info display speed may be limited due to network transfer rate, therefore resulting in slow data indication under poor networking speeds.

- There are certain app notice limitations between iOS and Android systems.
- There is a possibility that app functions may become unusable after upgrading iOS and Android software; some new cell phone models may have unusability issues.
- When using the noodoe function, make sure that the batteries of both the cell phone and scooter are fully charged. If you need to start the engine for charging, do it in a well-ventilated place.
- The noodoe system will be switched off automatically if battery power is low (about 12V) for 30s; if battery voltage is lower than 11.8V, please start the engine or stop using the system and go to a KYMCO dealer for checking the circuitry.
- The noodoe system may shut off and enter into protection mode due to excessive temperature rise under certain special environment or mode; however the system will resume operation when the temperature drops.

KEYLESS car key



The KEYLESS is the hi-tech electronic main switch that does not need a key (per the figure above). Each vehicle is equipped with 2 sets of remote controllers and they should be preserved carefully. If the wireless key is lost, then you will not be able to open the KEYLESS main switch. For this reason, you are required to preserve the wireless key carefully.



Warning

If both keys of the KEYLESS main switch are lost or damaged, please contact your dealer to provide inspection or replacement services.

Replacing the wireless key battery
Use appropriate tools for opening

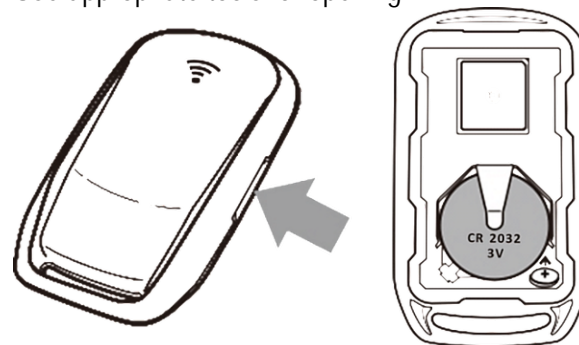

Model No. of wireless key battery: CR2032



Caution

Ensure the positive terminal of the battery is installed in the correct position.

Do not touch the circuits and terminals inside to avoid malfunctions.

When replacing the battery, do not apply excessive force to the keyless car key.

- If both sets of keyless car keys are lost or damaged, please visit the dealer shop for relevant inspections or replacements.
- When the keyless car key battery is low on power, it will affect the sensing distance. Please replace the battery as soon as possible.
- If one has electronic medical devices implanted in the body, please consult the physician or device manufacturers to confirm whether the radio waves will affect these medical devices.
- Do not expose the keyless car key to strong radio waves, or it may affect its functionality.
- Do not let the keyless car key come into contact with metal objects or coverings, or it may affect its functionality.
- The storage environment of the keyless car key should be free of humidity and high temperature.
- There are precision electronic components inside the keyless car key, please take note of the following items to avoid possible malfunctions or damages:
- Do not place or store the keyless car key inside the storage box, it may be damaged due to vibrations of road surfaces or overheating.

- Do not allow the keyless car key to drop, bend, or expose to strong impact.
- Do not immerse the keyless car key in water or other liquids
- Do not place heavy objects or apply excessive force onto the keyless car key.
- Do not expose the keyless car key to direct sunlight, high temperature or high humidity.
- Do not polish or attempt to alter the keyless car key.
- Keep the keyless car key away from strong magnetic fields or magnetic objects such as key rings, TVs, and computers.

KEYLESS sensing distance

Remote Sensing distance is approx. 0~5m but is for reference only, the real distance is subject to change:

1. Remote sensing antenna (single open space): The best sensing distance is within 1.5m; sensing is not possible past 3.5 m.

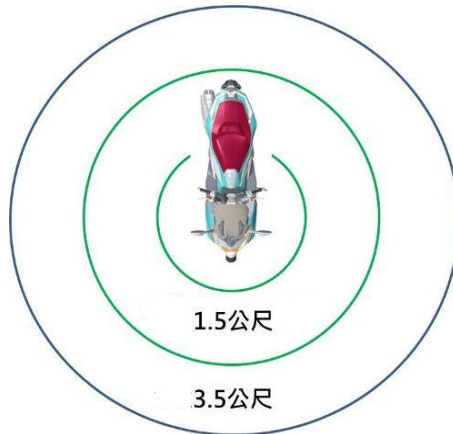

2. Short-range sensing antenna (single open space): Can only be sensed when in close proximity to the sensing symbol.



Caution

- The best sensing distance is 150 cm, but the actual sensing distance may differ due to environmental factors and battery power.
- When leaving the vehicle, ensure the handlebar has been locked, and the KEYLESS system has been shut off, and bring the keyless car key with you.

Short-range sensor

If the keyless car key is out of power and is unable to open the lock, the short-range sensor can be used to unlock.

Place the keyless car key on the right side of the center switch set, the short-range sensor symbol.



Short-range sensor symbol



Caution

- As the battery power of the keyless car key diminishes, it will affect the remote sensing distance.
- When replacing the battery, avoid inappropriate operations which may damage the functionality of the car key. Please visit the professional service station for inspection.
- The sensing distance is for reference only, and the KEYLESS button is still required to start the power.
- The keyless car key uses radio wave technologies, the range of operation will be affected by surrounding environmental factors. If the keyless car key is placed in the storage box or front storage box, it may affect the communication between the keyless car key and the vehicle, leading to poor sensing.
- If the keyless car key is out of power, it may affect the sensing range or even lose its remote detection function. When this happens, the short-range sensing function can be used instead. Place the keyless car key within the short-range antenna detection range near the right side of the switch set, press the main switch button for 2 short beep sound to unlock and

turn on power.

- Under power-on state, when the keyless car key leaves the short-range sensor location, if the vehicle is to be powered-off, it will make 10 warning beeps as reminder. Press the main switch button again to turn off.
- The keyless car key should be carried with you at all times. Do not place it in the storage box or on the vehicle.
- Take caution when the keyless car key enters operable range, as any person without the keyless car key but within sensing range may start the engine and ride the vehicle away.
- When the keyless car key is not within sensing distance, the vehicle may not be started.
- When the keyless car key leaves the sensing distance, there can still be instances of power consumption. When the user is unable to operate the KEYLESS main switch, the battery in the keyless car key should be replaced as soon as possible.

KEYLESS Main Switch



KEYLESS Main Switch

KEYLESS Controller Theft Prevention Setting – Remote Sensing (Locking)

- When the user stops the vehicle and leaves, please press the KEYLESS main switch button. The system will make a long beep sound, and this will complete the power-off and locking action.

KEYLESS CONTROLLER Theft Prevention Setting – Remote Sensing (Unlock)

- Press the main switch button, and the main switch will

make 2 short beep sounds. The screen will display the power-on scanning screen. The engine can be started once completed.

Caution

- Under engine non-ignition state, when the keyless car key leaves the sensing distance, the system will make a beep sound after 30 sec and turn-off.
- When travelling, when the keyless car key leaves the sensing distance, the engine will not shut down. It needs to be turned off manually in idle state.
- When the keyless car key is out of power or there is interference in the environment, leading to the ability to lock the vehicle, the short-range sensor can be used.
- It is strongly recommended that the user shall use Remote Sensing (Locking) mode to activate the Theft Prevention function.
- If you cannot operate the KEYLESS main switch from long range, please replace the wireless key battery or use the near-range sensing function to lock the vehicle.

KEYLESS controller anti-theft setting – short-range sensor (unlocking)

Place the back of the keyless car key near the right-side circular symbol of the center switch set and press the main switch button. The power will be turned on following 2 short beeps, and this will complete the unlocking action.



Caution

Under short-range sensor state, when the keyless car key leaves the short-range sensing location, the system will make 10 beep sounds before turning power off. Press again to turn power on.

Steering Stem Lock

To further prevent theft, the steering stem should be locked when parking the vehicle.

Vehicle locking method:

Under the power-off state, turn the steering stem completely to the left, long-press the "LOCK" button for 2 sec, a long beep sound will indicate successful locking.



Steering Stem Lock

Steering stem unlocking method:

Long-press the main switch button, the system will make 2 short beep sounds to power on, and this unlocks the vehicle.

Caution

- The system will make 4 short beep twice for unsuccessful lock. Please confirm that the steering rod is completely turned to the left and try locking again.
- The system will make 4 short beep twice for unsuccessful unlocking. Please confirm that the steering rod is completely turned to the left and try unlocking again.
- If the keyless car key is out of power, it needs to be operated through the short-range method.
- The levelness and safety of the parking location needs to be evaluated when locking and parking the vehicle, and lock the hand brake for safety.
- After locking the steering lever, confirm that the steering lever has been securely locked before leaving the vehicle.
- Do not park your scooter at locations where traffic safety may be obstructed.
- The wireless key storage position may affect the KEYLESS System (e.g. in the rear-side pocket or a backpack).
- After removing the wireless key, the vehicle will become inactive.

- The storage environment of the keyless car key should be free of humidity and high temperature.
- As the battery power of the keyless car key diminishes, it will affect the remote sensing distance.
- Avoid improper operating steps when replacing the wireless key.

If the wireless key is operating abnormally, please send it to the professional service station for repairs.

Main Switch Functions

- There will be 2 beep sounds when opening the main switch, indicating power-on. At this time, the dashboard will perform a screen scanning, indicating prepare for engine start. Short-press 1 time for a beep sound to turn off.
- To avoid risks of power cut-off by accidentally pressing the main switch, the main switch button is rendered inactive while the vehicle is travelling. It is only operable when idle.



Caution

Under any screen state, the screen will return to the main page when the vehicle is powered-off and turned back on.

When the unlocking of the steering stem is unsuccessful, please confirm that the steering stem is turned completely to the left, and try unlocking again.

Right Handlebar Switch



1. Park Alert Switch

 : Push this switch to the left, all the Park Alert Indicator (4 winkers, left and right, front and rear) will flash.

OFF: Push this switch to the right, all the Park Alert Indicator stop flashing.

 **Caution**

Do NOT use the Park Alert Light for prolonged period after stopping the engine, or power of battery will deplete.

2. Meter Change Button

Press it to enter the Meter mode.

3. noodoe Enter / Change Button

Press " O " to enter the selection menu and see the related noodoe information.

4. noodoe Pgup (^) / Pgdn (v) button

When operating the up (^) / down (v) button, the related noodoe information in the middle of the dashboard will change.

5. noodoe Change Button

Press it to enter the noodoe mode.

6. Engine Ignition Button

Be sure to pull up the front or rear brake lever when starting the engine electrically. After that, push this button to start the engine.

**Caution**



To prevent the battery voltage from becoming too low to start the engine, if the motor is running slowly after starting the engine, please send it to KYMCO dealer for inspection.

Engine Stop Switch

 : At this position ②, engine is stopped and cannot be started; it requires switching back to "○" position

to start the engine.

○ : At this position ①, starting the engine is allowed.

During normal riding, put the Engine Stop Switch at "" position. In the event of emergency, such as fuel cable jam or vehicle tumbling, turn the switch to "" position to force-stop the engine.

**Caution**

Please note! When travelling under high speeds, do not shut off or turn on the engine switch arbitrarily, to avoid dangers of collision or concerns to traffic safety due to loss of speed.

Left Handlebar Switch

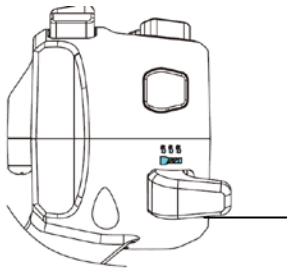
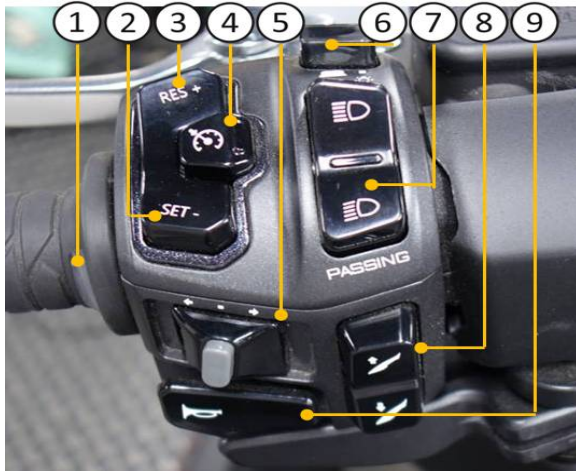

Handlebar Heater
button

1.Handlebar Heater / Indicator

After turning ON the Main Switch, press and hold Handlebar Heater Button for 3s or more to activate/deactivate Handlebar Heating Function.

After activating Handlebar Heater controller, click the button to select heating level in the sequence of 1 > 2 > 3 > 1 > 2 ...

- a.After turning ON KEYLESS Main Switch, a self-check is performed with the LED indicator flashing in a 1-white and 1-red format.
- b.After KEYLESS Main Switch ON and indicator self-check, in the event of a Handlebar Heater anomaly, the indicator will flash in red, with the Handlebar Heater function disabled. (Refer to anomaly states below for indicator flashing modes.)
- c.After KEYLESS Main Switch ON, press and hold the button to activate Handlebar Heater. Indicator lights in white constantly for normal operation.
- d.Turn KEYLESS Main Switch OFF or press and hold the button to deactivate Handlebar Heater. The indicator will go out, indicating the function is switched off.
- e.If Handlebar Heater is faulty, the indicator will flash in red.

Troubleshooting

After re-starting (Key Off → Key On) the vehicle, indicator will resume normal operation. Clicking the button when the indicator is flashing in red will stop the flashing. For the sake of your safety, please go to a KYMCO dealer for check-up.

Level 1 → Level 2 → Level 3



Dashboard Level Indication:

a. On activation of heating function, Dashboard will receive signal from controller and display the current heating level to the user.

b. Level Indication:

- Level 1: 45°C
- Level 2: 55°C
- Level 3: 65°C
- Heating Function OFF: All goes off.

(This is only the setting value; the actual temperature depends on the environment temperature and vehicle

condition, a difference may exist.)

c. If the signal from the controller to the dashboard is faulty for any cause, a  symbol flashes in the Dashboard.



Warning

- Please do not use the heating function for extended time if the vehicle is not under ignition state, this will result in early depletion of the vehicle battery.
- When restarting the vehicle, the handlebar heating function will be reset to off state.

2. Set/decelerate button (-)

3. Reset/accelerate button (+)

4. Cruise control setting button:

The vehicle speed must be greater than 45km/h to set the setting.

The steps are as follows:

4-1. Press cruise control button ON

4-2. Start the setting after the indicator is lighted.

4-3. Accelerate to the desired cruise range.

4-4. Press "SET" key.

4-5. Execute the cruise function

Caution

- After setting the desired speed, adjust the acceleration and deceleration between 45-130 km/hour (adjusted by 2 km/hour each time).
- Condition to cancel cruise control: 1. Pull the brake
2. Press the cruise control button.
- RES function: Press this button if the rider wishes to resume the previous speed setting after cruise control is cancelled.

Cruise Control Settings

1. Setting cruise control

- Press ON to set cruise control when indicator light is lit, begin setup

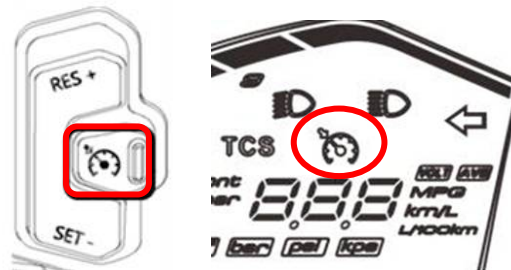

- Press the SET button to accelerate to the desired speed range. Implement cruise control function when indicator light is lit,

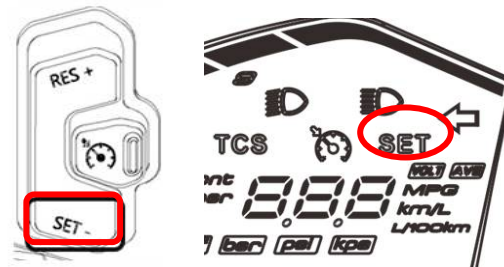

2. Cruise limit adjusting method

Under cruise control state

- Press RES (+) for acceleration to cruising speed increases.
- Press SET (-) for deceleration to cruising speed decreases



Caution

- After setting the desired speed, adjust the acceleration and deceleration between 45-130 km/hour (adjusted by 2 km/hour each time).
- Condition to cancel cruise control: 1. Pull the brake 2. Press the cruise control button.
- RES function: Press this button if the rider wishes to resume the previous speed setting after cruise control is cancelled.
- To release the cruise with brake, press "RES" again and you may return to the speed set last time. If you need to release the cruise with the "OFF" key, then set the cruise once again.

**Warning**

- Improper use of cruise control may cause failures, and lead to accidents. Do not use the cruise control system when riding in busy traffic conditions, bad weathers, or meandering, slippery, rough, or gravel roads.
- When going up or down a slope, the cruise control may not be able to maintain its cruising speed.
- To prevent from starting the Cruise Control System inadvertently, it should be shut down when not in use, please ensure that the cruise control indicator "  " is turned off when not in use.
- When the previous speed setting is too high for the current riding environment, it will be dangerous to use the resume function.
- The memory of previous the cruise set value will be cleared after shutting down the vehicle power for 30 seconds.

5. Blinker Switch:

Use the winker when making a turn or changing a lane. Pressing-in the button will deactivate the Winker.

⇐: This position is used for left turn.



⇒: This position is used for right turn.

The direction lights do not reset themselves automatically and should be reset after use. Failure to do so may affect riding safety.

6. Headlight switch:

Press this Headlight switch, the headlight is lit. Repress it to be headlight off.

7. High/Low Beam and Passing Light Switch:

Pushing the switch to "  " for HIGH, to "  " for LOW.

Over-pass Light Switch:

Pressing this button will activate High Beam.

8. Electric Windshield adjuster:

Press the upper button to lift the Windshield and press the lower button to down the Windshield.

9. Horn Switch:

Horn will sound when Main Switch KEY is turned ON.

Rear Brake Lever

Rear Brake Lever situates on the Left Handlebar; when applying the Rear Brake, hold the Front Brake Lever with left hand and apply a proper force on it.



Warning

- Improper operation may result in danger.



Caution

The rear brake handlebar is equipped with a position adjusting knob. Turn the knob and you can adjust the distance between rear brake handlebar and left handlebar. Please set the knob to the proper position and align with the Alignment Mark on the Rear Brake Lever.

Front Brake Lever

Front Brake Lever situates on the Right Handlebar; when applying the Front Brake, hold the Front Brake Lever with right hand and apply a proper force on it.



Warning

- Improper operation may result in danger.

Caution

The front brake handlebar is equipped with a position adjusting knob. Turn the knob and you can adjust the distance between front brake handlebar and throttle handlebar. Please set the knob to the proper position and align with the Alignment Mark on the Front Brake Lever.

Parking Brake Arm



Parking Brake Arm

This vehicle is provided with a Parking Brake Arm for locking up the rear tire, so as to prevent accident caused by rear tire movement when parking the vehicle on a slope.

Turn Parking Brake Arm to the left and click into lock position. To unlock, just turn Parking Brake Arm back to its original position (on the right).



Warning

- Never use the Parking Brake Arm while riding the vehicle, or loss of control of the vehicle and an accident may occur. Make sure the vehicle is fully stopped before using this Parking Brake Arm.
- When using the Parking Brake Arm, verify if rear tire is truly stopped from moving.
- Before riding your scooter, verify if the Parking Brake Arm is released, otherwise output power may be affected and the Parking Brake may be damaged.

Storage Box

Electronic

When the KEYLESS main switch is at KEY ON, press the "SEAT" button in the center switch to open the storage box.

Pushing the seat to its original position will close it up.



Storage Box Push button

The Storage Box is located under the seat cushion and it can be used to store the safety hat and other objects. If the KEYLESS Main Switch is on "KEY OFF" status, show the key near such main switch and you will be allowed to open the Storage Box without turning on the Main Switch. However, you cannot open the Storage Box if the KEYLESS Main Switch is outside the sensing range.

Do Not exceed the following load limits:

Storage Box	10 kg
-------------	-------



Storage Box

Components inside the Storage Box

LED

The lamp lights up when Seat Pad is lifted up, goes out when closed.



LED storage box light switch

Warning

- Store the safety hat with the most appropriate method. If the object exceeds the capacity of the Storage Box and you attempt to close the seat cushion forcefully, it may cause the seat cushion damage.
- For the purpose of theft prevention, do not put valuables in the Storage Box. Close the Seat Pad when leaving the vehicle.
- Please safe keep the physical key to avoid the predicament of replacing the whole set of keys.

Caution

- You may not be able to put the safety hat in the Storage Box due to the dimensions and the shape. Please select a safety hat that is suitable for the capacity of the Storage Box.
- Make sure not to leave the key in the Storage Box while closing it.
- To prevent mold generation, do not leave a wet raincoat or clothing in the Storage Box.

- Empty the Storage Box before washing the vehicle, so that objects do not get wet.
- Due to engine operation and environmental factors, the Storage Box tends to be warm and humid; do not put fragile, flammable or easy to decay objects in it.
- Please do not place alcohol, gasoline, volatile objects, lithium batteries, lighters, any electronic items, and items at risk of burning or explosion into the storage box to avoid danger.

Electric Windshield

Removal

1. Remove the two screws and then remove the front Windshield protection cover.

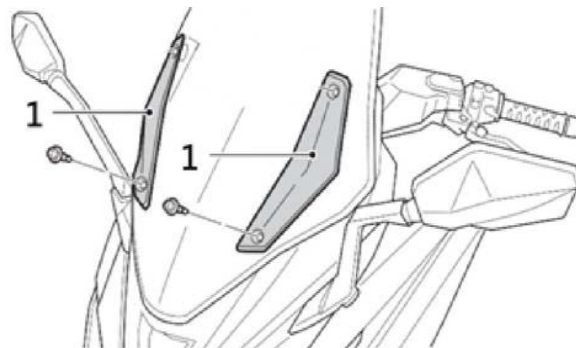

- 1: Front windshield protection cover

2. Remove the four screws and then remove the front Windshield.

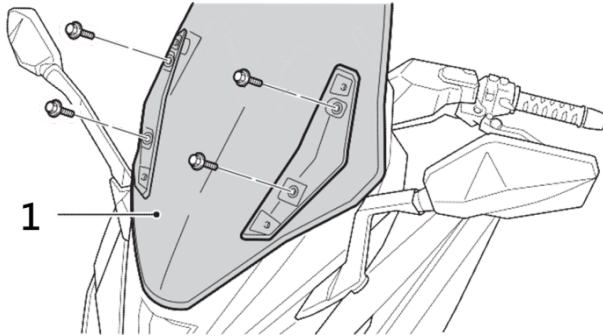

3. Installation is the reverse order of removal.
4. Tighten screws to specified torque.

Tightening Torque:
Securing Seat screws
20-28 N-m (204-285.6 kgf-cm)
Windshiled screws
10-14 N-m (102-142.8 kgf-cm)

**Warning**

Slackened Windshield can lead to accidents.
Make sure that screws are tightened to specified torque.

Rear View Mirror



Rear View Mirrors are the important equipment for securing the rider's safety before and during riding. Proper use of the Rear View Mirror is essential. Rear View Mirror is designed to be capable of turning forward and backward. When parking in a narrow space or putting down the vehicle, you may adjust the Rear View Mirror to a proper position.

**Warning**

- Adjust Rear View Mirrors to proper positions before riding the vehicle.
- To secure safety of the rider as well as other vehicles in behind, never remove the Rear View Mirror or replace them with inadequate ones.

12V Power Socket



12V Power Socket

This vehicle is equipped with the 12V power socket on the left front side inside the storage box.

Your may connect a low power consumption product to the Socket, for charging the product while the engine is running.

The maximum load for the power socket: 25W Max.

To avoid electrocution or short-circuit, make sure to cover-up the protection cap after using the 12V Power Socket.

To prevent any accident from occurring, park your

Scooter at a safe location before using the 12V Power Socket.

 **Warning**

- 12V Power Socket can only be used with a running engine.
- To prevent power depletion of battery, do not charge a product using the 12V Power Socket without running the engine.
- To prevent fuse from being blown, do not charge a product with a load exceeding 25W; if overheat occurs during charging, the system will cut off power supply automatically.
- After riding and before leaving the vehicle, make sure the product is unplugged and the Protection Cap is properly covered back.
- If the power is disconnected, reduce the load, turn off the main switch and then restart the power.
- Do not attempt to alter the power to prevent damaging the wiring system of the entire vehicle.

Main Stand

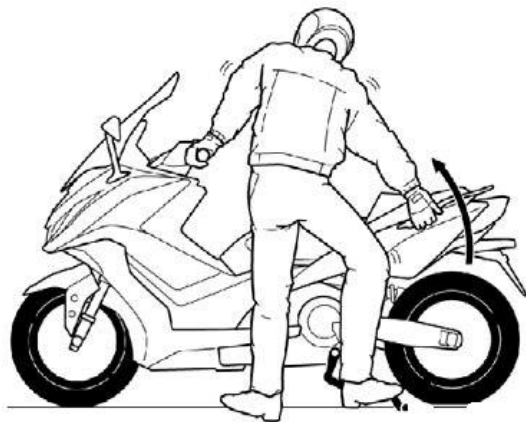

When parking with Main Stand, stop the engine and turn the Main Switch off. While keeping the vehicle perpendicular to the ground, holding the Left Handlebar with left hand and Rear Grip with right hand, thread upon the Main Stand using the right foot and exert force with both right foot and right hand to lift the vehicle up to a standing pose.

 **Warning**

- Make sure the Main Stand springs up fully before riding the vehicle.
- The Main Stand must not come in contact with the ground while riding the vehicle, otherwise it may interfere the riding and cause loss of control due to abrasion with the ground.
- Main Stand may fail to spring up to position while running the vehicle if the bracket spring becomes weak. Go to a KYMCO service station for replacement as soon as possible.

Fuel Filler Cap



The fuel filler cap can be seen after opening the seat pad.



Warning

- In order to prevent fire risks caused by fuel overflow from the Fuel Inlet, make sure the Fuel Tank Cap is fully locked after refueling.

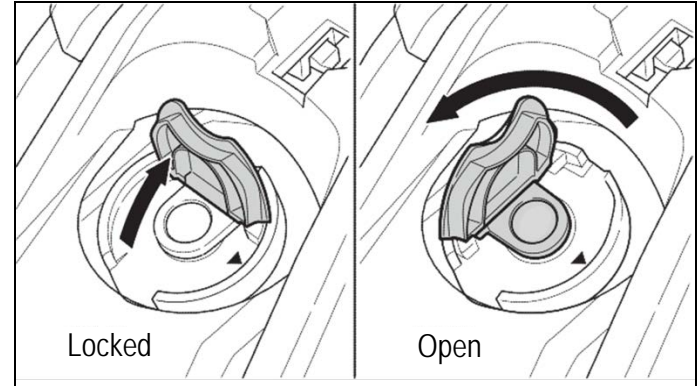

Open the fuel filler cap by lifting upwards, then twist to the left to open the cap.

Close the outer cover of the Gasoline Tank and then screw back the Gasoline Tank cover. After confirming that the Gasoline Tank cover is correctly restored, press the Gasoline Tank outer cover until it is latched securely.

TPMS, Electronic Tire Pressure Sensor

Operation instructions:

TPMS consists of 3 wireless Tire Pressure Sensors (per unit for two front wheels and rear wheel respectively, which are installed in the tire valve.) After sensing current tire pressure, the sensor will transmit such value to the controller wirelessly. The controller will then transmit the signal to the meter where it will be displayed through the meter and indicator in order to inform the driver about the current tire pressure value.

1. When the KEYLESS Main Switch is set ON, the Tire Pressure Sensor related Model Symbol on the left side of Dashboard will light up; if this symbol then goes out automatically, the tire pressure is normal (as shown in the Figure).

2. Described as below is the abnormal phenomenon:

Front Tire Pressure

$\geq 3.2\text{kgf/cm}^2$ or $< 1.6\text{kgf/cm}^2$

Rear Tire Pressure

$\geq 3.75\text{kgf/cm}^2$ or $< 1.65\text{kgf/cm}^2$

3. The owner needs to replenish or release tire pressure if the reading is too low or too high. Consult the dealer for

assistance if you have any questions.

(Standard tire pressure under normal inflation:

Front Tire 2.35 kgf/cm^2 ; Rear Tire 2.70 kgf/cm^2)

Warning

- Do Not remove wireless Tire Pressure Sensor or Controller, or TPMS function will be lost.
- No re-adjustment of TPMS is required when a new tire or rim is replaced.
- Re-adjustment of TPMS is required when replacing a new wireless tire pressure sensor and controller; please consult a KYMCO dealer.
- When replacing a tire rim, the Tire Pressure Sensor shall be kept in a correct order to distinguish the front one and the rear one.

Tire pressure indicator symbol

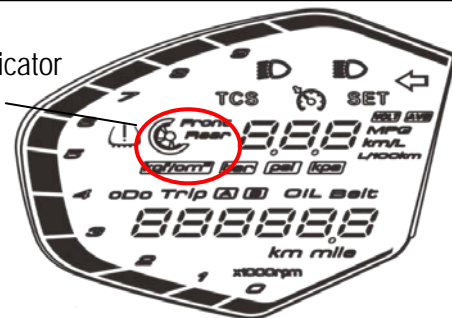

TPMS Learn Code Operation:

Applicable to owner and dealer service personnel.

Re-adjustment of TPMS is required when replacing a new wireless tire pressure sensor and controller.

When performing code learning, keep the vicinity clear of other vehicle or transmitter, to prevent miss-triggering.

Confirm that the electronic tire pressure detector has been correctly installed, that the tire pressure meets the intended pressure value and that the tires are correctly installed.

Learn Code Activation Procedure:

1. Press and hold the "MENU" button in the Right handlebar switch when the Tire pressure indicator symbol is indicated.

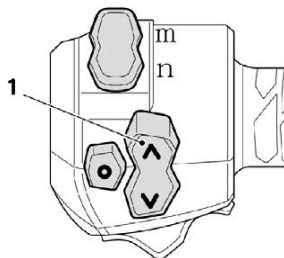

"MENU" button

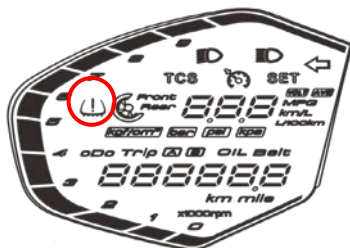

Tire pressure indicator symbol

2. Press the KEYLESS main switch to ON.
3. Wait until the image of tires appear and release the "MENU" button.
4. TPMS is now entered into Code Learning Mode.
5. ⌚ The front/rear tire symbol is flashing without the Tire Pressure value disappeared, indicates it is under code-learning state.
6. Flatten or refill the tire so that the change in tire pressure is greater the 3 psi, then the sensor will be activated within 1 min. Once there is a reading of the tire pressure, the code-learning settings of a tire is completed.
7. After the code-learning settings of a tire is completed, it will automatically go to the next tire for code-learning.
8. The operator will also go the next tire and repeat the above steps for code-learning settings.
9. If one wishes not to code-learn, press the "∧" button to skip to the next round of code-learning. If code-learning is not completed within 2 mins, it will exit the code-learning mode.
10. After the code-learning settings, press the "∧" button to leave exit, or press KEYLESS main switch ON-OFF to restart.

**Caution**

- After acquiring the vehicle, inflate the tire till over 20 psi and then let the TPMS PC learn the initial value automatically so that it may operate normally in the future.
- Re-do Code Learning after replacing parts.
- Because the tire pressure detector is mounted on the nozzle position, keep the tool-inserting position away from the nozzle when replacing the tire.
- Make sure the direction is correct when replacing a part.
- Tire Pressure values are for reference only.
- Slackening of nut during parts installation will cause air leakage.
- If the tire pressure cannot be detected, it means the tire pressure detector battery is running out of the power. In this case, make a part replacement.

Change Pressure Unit

Turn KEYLESS Main Switch ON, the Model Symbol will light up.

Push the Dashboard and noodoe Switch to "m" position and press the UP button to change over to TPMS Mode. Pressing "O" button on the Right Handlebar Switch to change units in the sequence of [kgf/cm² → bar → psi → kpa].

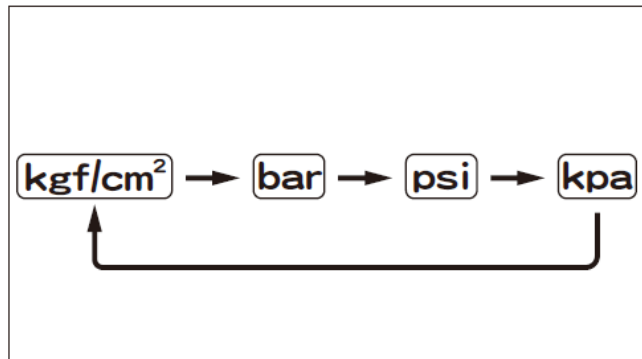

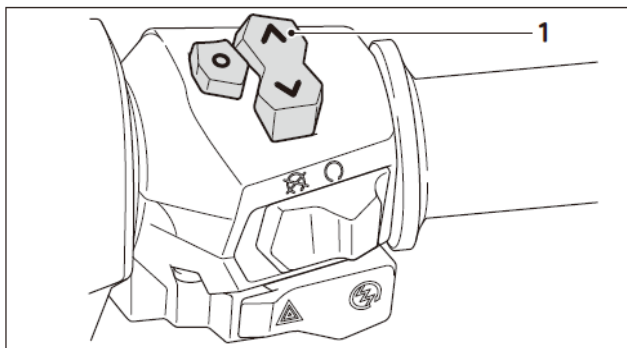

1: Change Pressure Unit Switch

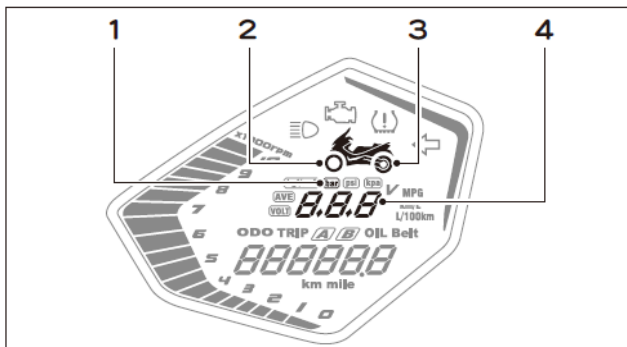
1: Pressure Unit
3: Model Rear Wheel2: Model Front Wheel
4: Tire Pressure Display Zone**TPMS abnormal status:**

Depending on the TPMS error state, the dashboard will display with the indicator light and the message bar as well as the tire pressure screen. The messages are as follows.

1. With Main Switch set to ON, when Tire Pressure Indicator in the Dashboard lights up continuously, it may be due to a pressure $> 3.2 \text{ kgf/cm}^2$ or $< 1.6 \text{ kgf/cm}^2$ of Front Tire; or a pressure $> 3.75 \text{ kgf/cm}^2$ or $< 1.65 \text{ kgf/cm}^2$ (23.4psi) of Rear Tire. Change over to TPMS Mode by pressing the Mode button, the tire pressure value will be flashing.
2. Tire Pressure Indicator will light up continuously if controller is faulty. Change over to TPMS Mode by pressing the Mode button, the "Err" symbol will appear.
3. Tire Pressure Indicator will light up continuously if signal of tire pressure sensor fails to reach the controller due to environmental interference. Change over to TPMS Mode by pressing the Mode button, " --- " will appear.
4. Tire Pressure Indicator flashes quickly if tire pressure drops fast; it flashes slowly if tire pressure drops slowly.

ABS (Anti-lock Braking System)

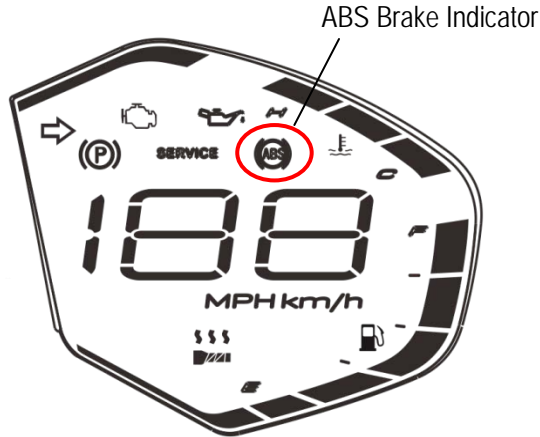

The ABS Brake System is designed in double-electronic control mode. It can be used to activate the front, rear and pedal brakes separately. When ABS is activated, the rider can feel pulses acted by ABS on the handlebar; in which case the rider needs to hold the handlebar constantly, without "press-and-releasing" it, or the ABS effect may be diminished.

The ABS Brake Indicator situates on the left upper corner of Dashboard (as shown in the figure); it lights up when the

Main Switch is activated and does not go off automatically. The ABS Brake Indicator only goes off when engine is started and vehicle runs above 6 km/hr.

Caution

- ABS is controlled by ECU; if ABS fails, the ABS Brake Indicator will light up; ABS may lose its function, but the original brake still works; the ABS resumes normal braking functionalities.
- When riding on a rough or pebbled road surface, effective ABS braking distance will become longer.
- Always keep a proper safety distance with preceding vehicles while riding a scooter.
- ABS gives optimal performance with a longer braking distance.
- To avoid deterioration of ABS performance, do not remove or damage the wheel sensor or the rotor of wheel sensor.
- When activating power of KEYLESS Main Switch, or when vehicle speed exceeds 6 km/h, ABS will execute a self-diagnosis. During this self-diagnosis session, a vibration may be felt on the Brake Lever if you pull it gently, which is a normal phenomenon.

- In the event of an emergency brake in response to a special road condition, ABS system helps preventing a locked wheel resulting from the sudden braking action, allowing the rider being able to steer the vehicle smoothly. An ABS system controls the braking force automatically to prevent the tire from skidding.
- An ABS system will not shorten braking distance in the following conditions: when running on a soft and unlevelled road or a descending slope, the braking distance is even longer than a vehicle without ABS. Therefore models with ABS have the optimal performances on flat road surfaces.
- An ABS System comprises an ABS ECU and front and rear tire speed sensors. Using tires not conforming to original specifications may affect the detection of speed sensors and result in abnormal ABS activation.

 **Warning**

- Using tires not conforming to original size specifications may result in malfunctioning of the ABS system, or even an accident of the rider due to malfunctioned activation of the Anti-lock Braking System. Therefore it is a must that you use tires conforming to KYMCO specifications.
- When ABS activates, you may feel a light vibration on the Brake Lever, which is a normal phenomenon.
- When vehicle speed is below 6 km/h, the ABS system will not activate.
- When the power fails or the system is faulty, it will lead to the failure of the ABS System. At this time, the ABS brake indicator will be lit.

TCS (Traction Control System)

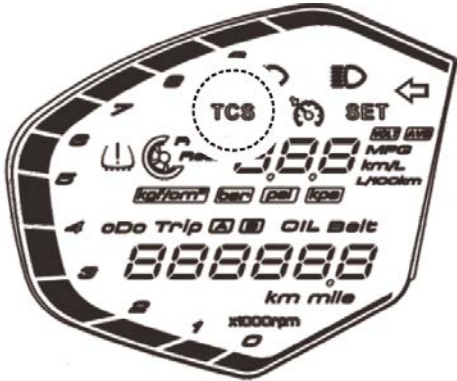

The indicator light will light up in amber color if TCS is on when turn on the main switch. Once the vehicle speed is over 6 km/h, the indicator light will go off automatically. The TCS keeps function at this time.

Following indicator condition is

- Does not light up: TCS is on but not function.
- Flashing in amber light: TCS is on and is functioning.
- Solid amber light: TCS is malfunction. Please have a KYMCO dealer check the vehicle as soon as possible.
- Solid green light: TCS function is is off.

Press “MODE” key to start switching:

1. NORMAL (orange) + TCS ON (orange)
2. RAIN (blue) + TCS ON (orange)
3. NORMAL (orange) + TCS OFF (green)

(Left handlebar switch)

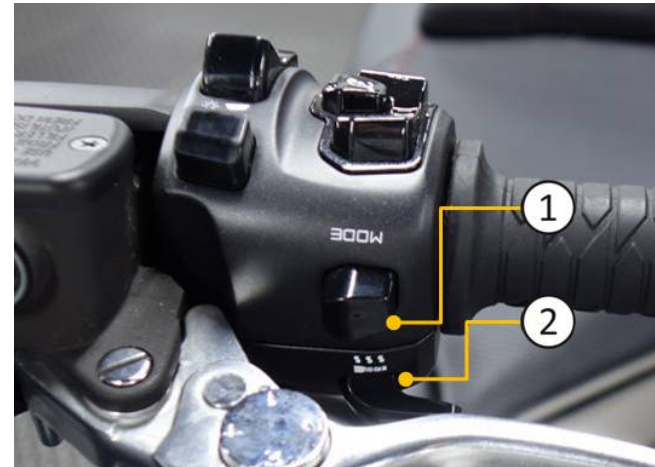

1. Normal / Rain / TCS mode switch
2. Handlebar heating button

**Caution**

- Engine remains inactive under KEY ON and you may switch between 1, 2 and 3 freely as required.
- After starting the engine, you may switch between 1, 2 and 3 freely as required under idling status.
- After starting the engine, do not switch between 1, 2 and 3 when riding the vehicle.
- TCS indicator: After turning on the Main Switch, the amber lamp stays illuminated and then extinguishes when speeding up to over 6 km/h.

AIBS (Advanced Integrated Brake System)

When using with the IMU Inclination Angle Sensor, the AIBS System can detect the inclination angle of the vehicle when negotiating through a curve section. When equipped with the ABS/TCS System, it also calculates the optimal braking force and optimal traction force in order to achieve the stabilized curve negotiation performance.

If the vehicle becomes uncontrollable, the AIBS will intervene and exhibit the optimal brake control or optimal torque control to maintain the vehicle body in a stabilized condition so as to realize full-scale safe driving.

**Caution**

- Being an auxiliary function, the curve-negotiation feature only applies to the physical limit that is designed for the curve-negotiating applications (excessively large inclination angle will exceed the physical limit and the scope designed for the auxiliary system).
- The AIBS is not intended for the user to execute private maintenance and is extremely sensitive as well. Please do not attempt to make any dismantling, modifying, position changing or support frame material changing to avoid affecting the IMU performance.
- Please keep the IMU from excessive impact.

Introduction of TCS

If rider gives too much throttle or rides on a slippery surface like an ice-covered road or a wet road and etc., it may cause the rear wheel slipping. The traction control system helps the vehicle maintain traction when above situation happens. If sensors detect that the rear wheel is starting to slip (uncontrolled spinning), the TCS assists by regulating engine speed until traction is restored. You may notice changes in engine response or exhaust sound.



Warning

- The TCS is not a substitute for riding appropriately for the conditions. The TCS cannot prevent loss of traction or front wheel-slip while rider is entering turn in excessive speed or accelerating hard at a sharp lean angle or braking too hard. As with any vehicle approach surfaces that maybe slippery with caution and avoid especially slippery surfaces.
- Use only the specified tyres. Using different size tyres will result the TCS cannot operate accurately that may cause hazardous situation.

- NOTE: Turn off the TCS is recommended before start the engine in a cold weather, if open the throttle to make the engine start or warm up easily is necessary. After that, turn on the TCS.



Caution

- The TCS will turn on automatically when main switch restarts.
- Turn the TCS off to free the rear wheel if the vehicle gets stuck in mud, sand, or other soft road surfaces.
- When the vehicle is on the center stand and the TCS is on, do not attempt to wide open the throttle for an extended period of time to avoid the spark plug wetting or cause the indicator light remains on due to the malfunction detected.
- The TCS will lose function and the indicator will light up when the battery malfunction or died.

O2 Sensor

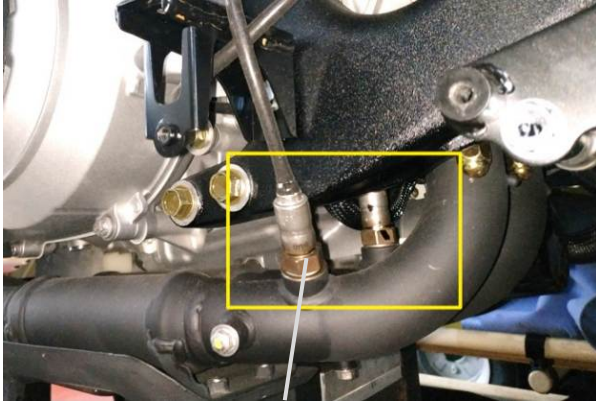

O2 Sensor

The vehicle is equipped with O2 Sensor. It is designed to reduce the pollutants that will be emitted from the exhaust gas.



Warning

Do not attempt to dismantle or replace the O2 Sensor, or it may lead to defective function or even failure of the O2 Sensor.

Muffler and Catalytic Converter

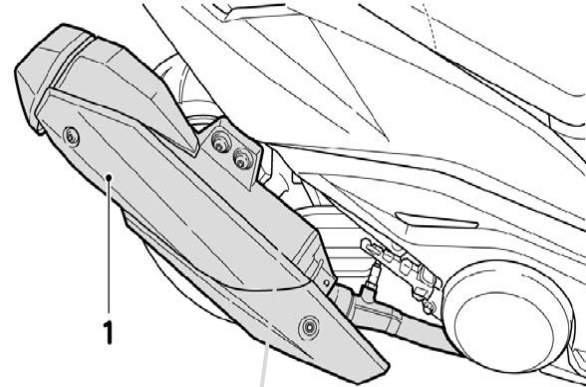

Muffler

Catalytic Converter is used for reducing generation of pollutants in the exhaust gas.



Warning

After using the vehicle, the exhaust system becomes extremely hot due to heat from the exhaust gas.

To prevent fire or burn:

- Park the vehicle properly so that pedestrian or children cannot reach.
- Do not park the vehicle in the vicinity of flammables.
- Make sure the exhaust system has cooled off before performing any maintenance.
- Never turn off the main power switch while riding the vehicle. Otherwise a great amount of non-burnt gas mixture will enter into muffler and combust there, damaging and burning the Catalytic Converter.
- Use only unleaded gasoline; leaded gasoline can result in aging and failure of Catalytic Converter.

Exhaust Control System

Complying with EPA Exhaust Emission Standard, the scooter is equipped with following parts in the Exhaust Control System:

- Electronic Control Unit (ECU)
- Crankcase Ventilation Valve
- Catalytic Converter
- Throttle

Various sensors:

- Air Intake Temperature Sensor
- Air Intake Pressure Sensor
- Throttle Position Sensor
- O2 Sensor
- Temperature Sensor

Proper Riding Method

Starting the Engine

- Lift up Main Stand before starting the engine.
- Check oil and gasoline content before starting the engine.



Engine Stop Switch

- ⊗: Engine will stop and cannot be started when setting switch to this position. Re-start of engine is only possible after setting the switch to ⏻ position.
- ⏻: The Engine can be started when setting the switch to

this position.

⚠ Caution

- The Main Power is cut off when the Engine Stop Switch is set to the ⊗ position, therefore pulling the Brake Lever and pushing the Start Button will not activate the motor.
- The Engine Stop Switch is meant for a temporary engine stop only.



1. Confirm that the KEYLESS car key is within sensing range.
2. Press the main switch button to turn power ON.
3. Make sure the throttle grip is fully closed.
4. Confirm that the engine stall switch has been switched to "⏻".

5. Hold the front brake lever or the rear brake lever, and then press the “Electric Start” button and the engine will become active.



6. If starting is difficult, release the Start Button and wait for a few seconds before trying again. Each re-try shall not exceed 5 seconds, for preserving battery power.

Caution

- When not in use after stopping the vehicle, be sure to set the main switch key to the “OFF” position to prevent the battery from discharging excessively.
- Keep finger off from Start Button immediately when engine starts.
- Never push the start button when engine is running, or engine parts may get damage.
- When starting the engine, the rear brake lever shall be set to braking state, the brake light shall light up when the power is connected.
- Allow a brief warm-up after starting a cold engine (about 1-2 minutes), in mountains and cold areas, prolong the warm-up (about 3-5 minutes), for facilitating engine operation and a trouble-less riding.

Warning

- Before advancing, keep the Rear Brake Lever in braking state. DO NOT raise engine rpm arbitrarily.

Proper Riding Method

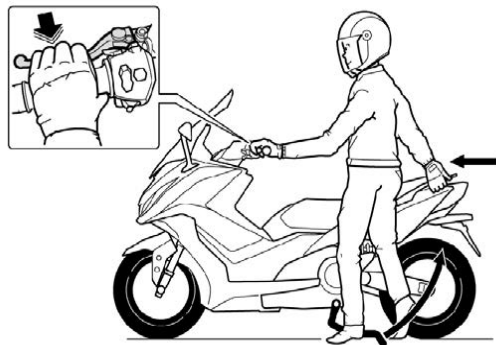

- Keep the Rear Brake Lever in braking state and push the vehicle forward, the Main Stand will spring up automatically.
- Mount the vehicle from the left side and then sit squarely, with both feet touching the ground to prevent tilting. Adjust the rear view mirror to the intended position.



Warning

- Keep engine rpm away from the red zone.
- After starting the engine, do not raise engine rpm while not advancing the vehicle, or danger may occur.
- Before advancing, keep the Rear Brake Lever in braking state. DO NOT raise engine rpm arbitrarily.

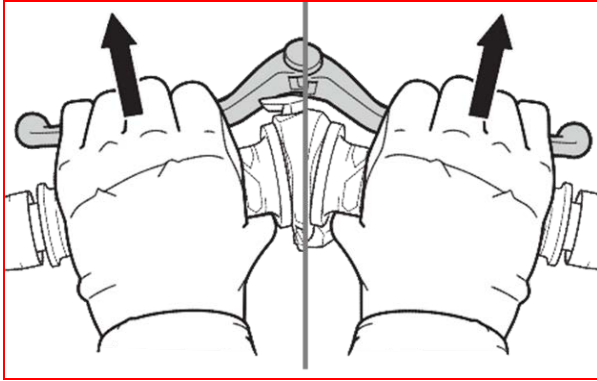
Release Front and Rear Brake Levers



 **Warning**

- After releasing the brake, do not turn the Throttle Grip arbitrarily, or the vehicle may dash out dangerously.

Turn the Throttle Grip to adjust scooter speed.

 **Caution**

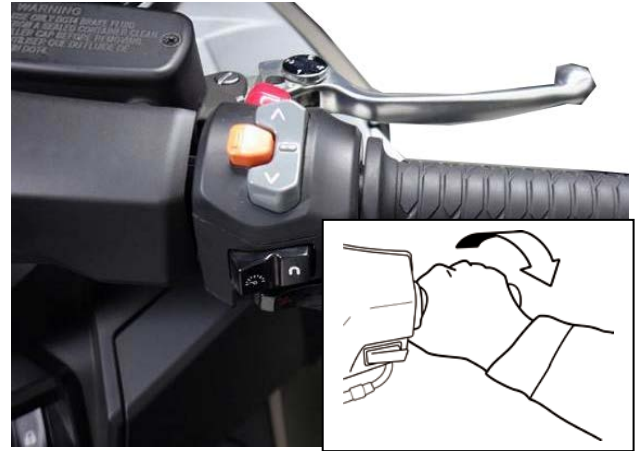
- For prolonging engine service life, do not speed up suddenly when the vehicle is still cold.



- Speed is controlled by adjusting the Throttle Grip.
- The more the turning range, the quicker the vehicle speed. Increase fuel (throttle) slowly
- When taking off or riding on an up-slope, slowly turn the Throttle Grip to increase horsepower.
- When returning to the original position, the vehicle will reduce its speed. Be agile while returning the Throttle Grip.
- Do not turn the Throttle Grip rapidly, or the vehicle may

dash out.

Proper Riding

Before taking off, switch on the winker, check traffic conditions both directions, slowly turn the Throttle Grip to start.

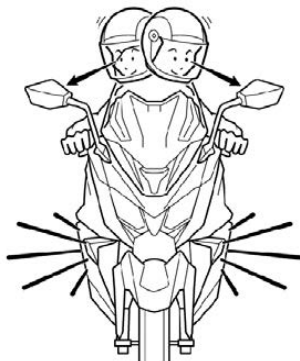

Running-in a new engine

Run-in Period of a new engine is 300 km; keep speed under 80 km/h in this period.
Avoid speeding-up rapidly.



Warning

- High-speed riding in the run-in period may result in worn engine parts.

Brakes

Front Brake

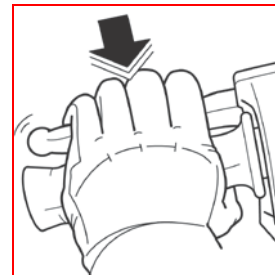

Rear Brake

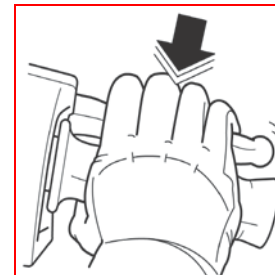

Warning

- Braking on a wet or sandy road requires a longer effective braking distance and is more difficult.
- Slow down while running on mountain roads; it will be more difficult to brake while running down-slope, more dangerous as well.
- Do not brake or turn abruptly.
- Abrupt braking and turning are the causes for the extremely dangerous side skidding or tumbling.
- If you lack confidence about the operations of this vehicle, please proceed slowly to practice and familiarize yourself with the braking system.

Proper Parking Method

When approaching to a parking location:

Switch on the winker in advance and take heed of vehicles behind you while slowly pulling-over.

Restore the refueling handle to its original position and then use the front / rear brakes at an earlier stage. At this time, the brake lamp will be lit in order to warn vehicles approaching from behind.

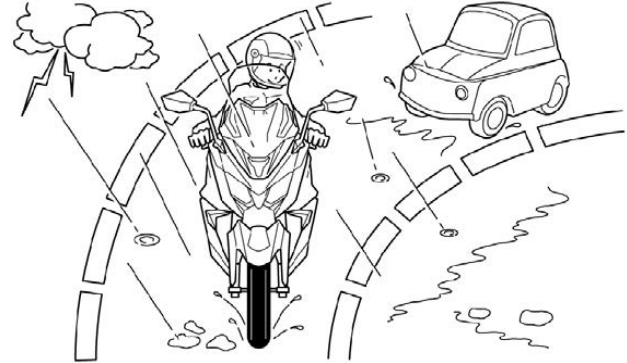

Warning

- During rainy days, special care should be used when operating the motorcycle as the road surface condition during rain is different from that of sunny days. Because a longer braking distance will be required, reduce speed and use the brake at an earlier stage.
- When running down-slope, return Throttle Grip to closed position and apply brake intermittently to slow down the speed.
- Avoid forceful or emergency braking especially when the vehicle is tilting to one side, or a side skidding or tumbling may occur.

Warning

- Wet road surfaces as well as railroad crossover, light rail track, manhole cover, and steel plates covering the construction sections are very slippery;
- Slow down and take extra caution when passing them.

At full stop of vehicle

Turn off the blinker. Turn off the KEYLESS Main Switch.



Warning

- If the KEYLESS Main Switch can be turned off during the crusing process, it means the fail-safe function has failed. Go to a KYMCO dealer or service station for repair as quickly as possible.
- To prevent theft, lock the steering lever when leaving the vehicle after parking and please also keep the wireless key with you at all times.

Parking the Vehicle

- Standing on the left side on a flat ground, the rider shall brace the Main Stand up.
- Brace the Main Stand up on a flat ground not impeding the traffic.
- Bracing up the Main Stand on an unlevel ground may result in tumbling of vehicle.
- Hold the Handlebar with left hand and keep it straight; while treading down the Main Stand with right foot, grasp the Left Rear Grip beside the Seat Pad with right hand and pull upwards forcefully.

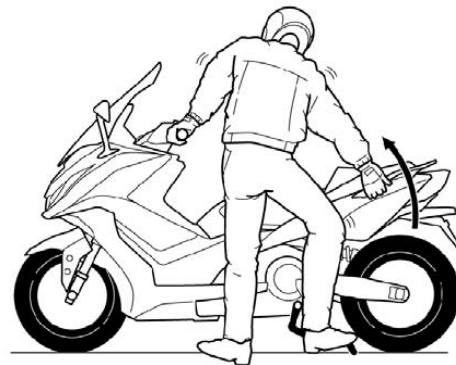

A tumbled vehicle

To restart a tumbled vehicle with engine stopped, you need to turn the KEYLESS Main Switch off and on again before restarting.



Warning

- To prevent the leakage of gasoline from the tipped over vehicle leading to dangers, the main switch should be turned off manually, or the ignition switch be set to the shut-off position when the vehicle is tipped over.
- If the vehicle cannot be lifted, do not lift by force to prevent the vehicle from tipping over again from imbalance. When necessary, request the assistance of others to lift the vehicle.
- If personnel are stuck under the tipped vehicle, call out for help accordingly, as it is outside of personal capabilities.

Checks before Riding

Keep a good habit to perform checks before riding. For keeping your vehicle in a safe and effective operating condition, perform regular checks, adjustments and lubricating maintenance according to the Maintenance Program.

Exhaust Control System can reduce generation of pollutants in the exhaust gas of your scooter. Please perform maintenance according to specified mileage or schedule, for ensuring compliance with exhaust emission standards.



Warning

- If you are not familiar with the motorcycle inspection and maintenance, please contact KYMCO dealer for services.
- Injury or electrocution may occur if anybody part or clothing touches a running engine. Please stop the engine while performing vehicle maintenance.
- For preventing burning hazard after riding a vehicle, touch its engine, muffler, brake disc, brake caliber or brake pad only after it has cooled down.
- When performing maintenance, never run the engine in an enclosed space; there is a risk of carbon

monoxide intoxication due to exhaust emission.

- To avoid damaging the vehicle, never carry out any maintenance without receiving a professional training or lacking of a special tool.

Engine Oil and Oil Filter

Before riding the vehicle, check engine oil for compliance with level requirement or any leakage. Engine Oil and Oil Filter shall be replaced regularly according to maintenance and lubrication schedule.

Check/Replenish Engine Oil

1. Park the vehicle on flat ground and brace up the Main Stand. Activate KEYLESS Main Switch and start the engine, idle it for about 3 minutes without using Throttle Grip, then stop the engine. Allow resting for another minute.
2. Pull out Oil Level Guide and wipe it clean, insert the Oil Level Guide without screwing it in.
3. Check the oil level; when the oil surface nears L, please refill the engine oil to between M and L.

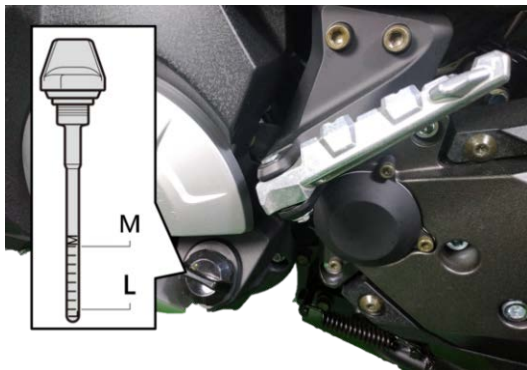
**Caution**

- Engine and Muffler are extremely hot. Take special care to prevent burn while checking oil level.
- After warming up the engine, stop engine and wait for 1 minute; then verify oil level with Oil Level Guide.

Recommended Oil Specification

Specification:

SAE: 10W/40 MA

API: SL Class or better

First oil change when running 1000 km;

Second oil replacement: 5,000km

Third oil replacement: 10,000km.

Subsequent oil replacement Every 10,000 km.

**Warning**

- There are many inferior oils in the market which may cause engine failure if miss-used by the consumer.
- To ensure oil replacement of your beloved vehicle with recommended specifications, please go to the dealer where you purchased your vehicle from.

**Caution**

- A slanted vehicle may lead to a faulty verification of oil level.
- If oil is checked or replaced immediately after stopping the engine, be especially careful not to get burnt.

Check/Replenish the Fuel

Replenish gasoline as soon as possible when the Fuel Indicator on the Dashboard approaches the last segment near E.

Replenish with #95 Unleaded Gasoline as soon as possible.

Using Fuel Tank Cap

Stop Engine first

1. Turn KEYLESS Main Switch to OFF position, keep turning clockwise to the end will open the Fuel Tank Outer Cover. Then open Fuel Tank Cap.
2. Use only #95 unleaded gasoline or better.
3. Restore the Fuel Tank Cap until it is properly positioned. Check if the Fuel Tank Outer Cover is securely latched.



Warning

- DO NOT smoke when replenishing gasoline.
- Stop engine when replenishing gasoline.
- When replenishing the fuel, keep the fuel level below the baseline plate, otherwise the fuel will overflow.
- It is recommended to add "Kymco Nozzle Cleaner" in the fuel every 10,000 km when replenishing the fuel, for cleaning Fuel Injection Nozzle.
- Avoid operating Fuel Pump for prolonged time when the Fuel Tank is empty, which may affect normal service life of Fuel Pump.

Check Steering Stem

- Check for any slackening by swaying it up and down, forward and back, and left and right.
- Check if Handlebar is too tight.
- Check the Handlebar for any colliding.
- Left-right turning steer. The steering link components shall not present any loosening sign.
- When finding any anomaly, go to a KYMCO dealer or service station for repair.

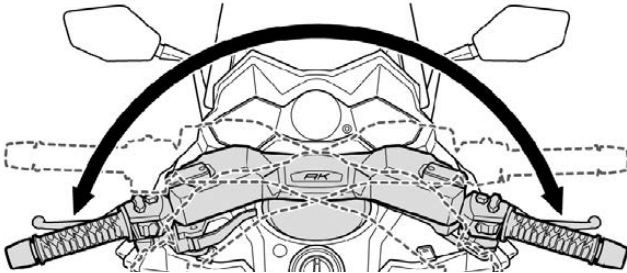

Check and adjust the front and rear brake components.

- Adjust brake lever clearance using adjustment knob (totally 4 adjustment positions).
- Push the brake lever forward when adjusting the knob (default setting is 3).
- After adjustment, pull the Brake Lever (1) with hand until reaching a position where fingers feel comfortable; check if the clearance at the front end of Brake Lever is within the specified dimension.
- The pedal distance of the foot brake is automatically adjusted by default. If the pedal distance is found to be larger than normal or is faulty, please visit the dealer shop for repairs.



Adjust brake lever

Inspection of front/rear brake oil

1. Set the handlebar squarely and then check the brake oil in the left and right fuel tank. Keep the level between the Upper Mark and Lower Mark.
2. If the oil level is approaching the lower limit " L " mark, check the abrasion extent of the brake lining.
3. If the brake lining is not worn exceeding a specified limit, most likely there is a leakage of brake fluid; go to a dealer for repair.



Brake oil peep window

Front / rear brake oil replenishing

- Straighten the Handlebar, remove 2 fixing screws of Reservoir and remove Reservoir Cover.
- Replenish Reservoir with recommended DOT-4 Brake Fluid to the Upper Scale. Install Reservoir Cover and tighten 2 fixing screws.
- Replace Brake Fluid every 10000km or 1 year.



Warning

- Mixed use of brake fluids of different brand and different specifications may result in braking fault and danger.
- When replenishing the braking fluid, cover painting parts with a cloth to prevent damaging them.

Checks before Riding

Check Front/Rear Brake Lining

- Is braking effective?
- Verify the braking effect of the front and rear brakes at low speed.

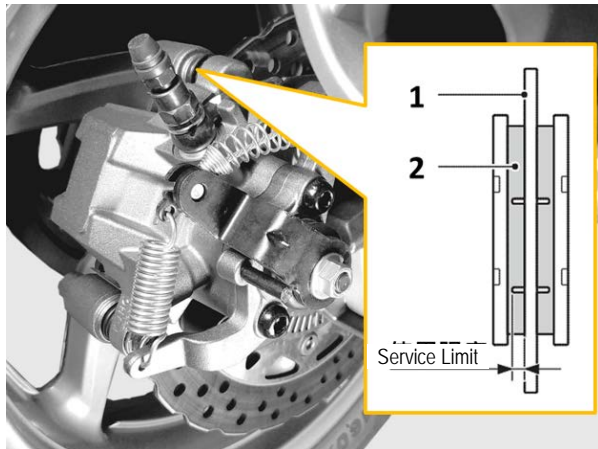

1. Brake Disc 2. Brake Pad Lining

• Check Brake Lining Limit

Check the brake lining when the wear limit is reached, please contact the KYMCO dealer shop for replacement.

Check Tires

- Check the ground-contact status of the tire and see if the tire air pressure is normal. If low, inflate the tire to reach normal pressure.
- In case of a gripping anomaly, check tire pressure for normal readings using a pressure gauge.

Pressure measurements of cool tire:

Front wheel	Rear wheel
2.35 kgf-cm ²	2.70 kgf-cm ²

- Check the tire grooves for any metal or pebble chips; remove them, if present, before riding.
- Replace the tire if there is a fracture or the limit of the groove depth is reached.



Warning

- When the tire pressure is very low or the tires are incorrectly balanced, riding of the vehicle will lead to dangerous rotational vibrations.

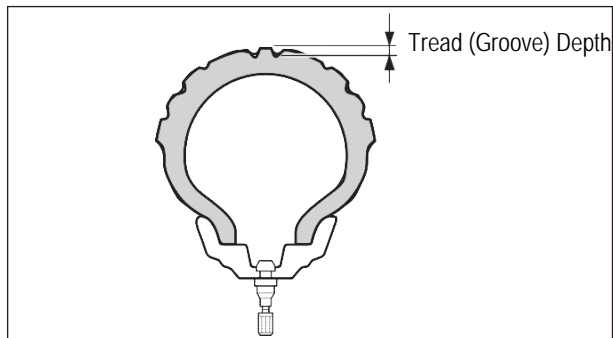

(See arrow indication in the drawing.)

Measure the groove depth at the center of the tread pattern. Take measurements at several points since uneven wear may occur.

Replace the tire if any of the measurements is lower than the service limit. Make sure the wheel is properly balanced when a new tire is replaced.

Service Limits:

Front Tire 0.8 mm

Rear Tire 0.8 mm

Tire groove abrasion inspection: Check the tires before starting a journey.

In case of finding a transverse line (minimum pattern depth), nail or glass chip on the tire, or crack line on the side wall of tire, go to Kymco dealer for replacing with new one.

Excessive wear of tire tread pattern will result in reduce friction and the tire will become more prone to be punctured; it also affects safety of operation.

Tire Specifications:

Front Tire Specifications:

120 / 70-R15

Rear Tire Specifications:

160 / 60-R15

Checks before Riding

Check the Brake Light

Turn on the KEYLESS main switch power.

Respectively pull the Front and Rear Brake Levers, verify if Brake Light goes on.

Check Brake Light for stain or fracture.



Caution

Turn KEYLESS Main Switch to "ON" but Engine Stop Switch to "OFF".

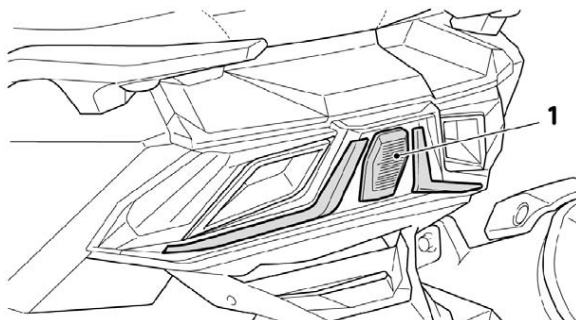

1. Brake Light

Check the Tail Light

Turn on the KEYLESS main switch power.

Check if the Tail Light goes on.

Check the Tail Light Lens for stain or fracture.

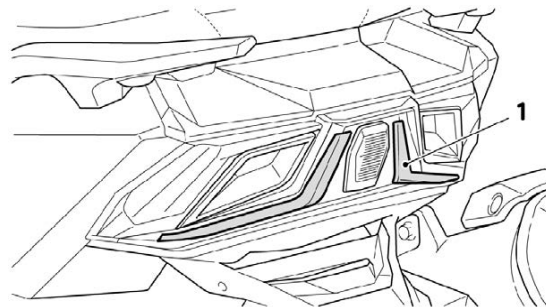

1. Tail Light

Check the Headlight

- Turn on the KEYLESS main switch power.
- Turn on ignition of the engine.
- Check if the Headlight goes on.
- Check the Headlight Lens for stain or fracture.

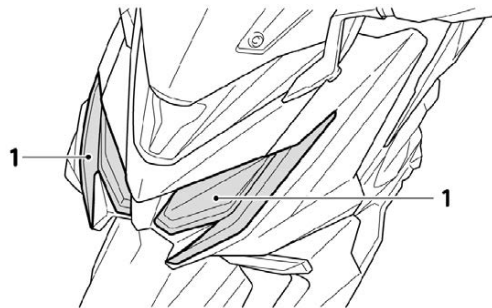

1. Headlight

Check Winkers

- Turn on the KEYLESS main switch power.
- Operate Winker Switch to verify if each Winker works.
- Check Winker lens for stain or fracture.

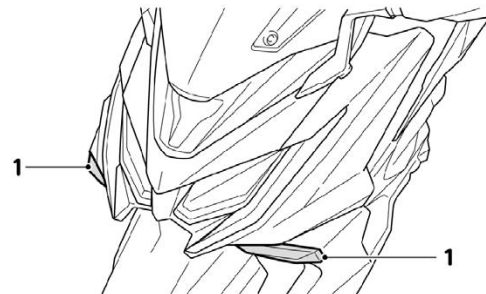

1. Front Winker

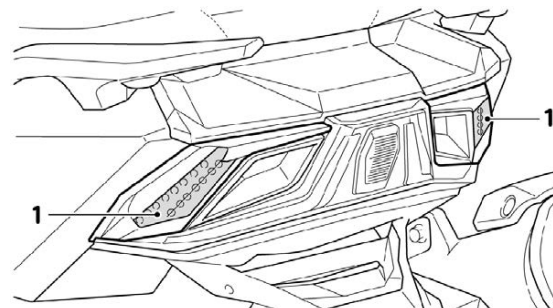

1. Rear Winker

Check Front/Rear Cushion

Hold the front brake. Press the handlebar hard several times and then check if the front fork is operating and bouncing smoothly. When detecting any damage or if the front fork cannot operate smoothly, please contact KYMCO service center for inspection or replacement.



- Check if Head Light, Tail Light or Winker goes on normally.
- Start engine and turn on switches, check if Head Light, Tail Light or Winker goes on normally, and check for any stain or fracture on the light lens.
- Check Dashboard for normal display.
- Check the Horn for working normally.
- Set the KEYLESS Main Switch in the "START" position

and then press the "HORN" button switch.

- Check Rear View Mirror for proper angle.
- Sit yourself on Seat Pad and check the rearview of the mirror; also check for any damage or stain.
- Considering actual riding safety, a torque is specified by the statutory regulation as of 1.02-1.428 Kgf-m. Therefore when fixing the Rear View Mirror onto the vehicle, it shall not be totally rigid (either exceptionally loose).
- Check the License Plate for any Stain or Damage.
- Check License Plate for any stain or damage; secure it tightly.
- Check for normal exhaust gas.
- Check Muffler for slackening or noise.
- For any others, check if previous anomalies still exist.

Inspect the outer transmission belt



- Erect the vehicle with the main stand, rotate with rear wheel manually, visually inspect whether the outer belt has abnormal scuff marks.
- Whether there are foreign objects attached, and remove them.
- Whether the belt and the pulley are rubbing on a single side, and has no more gap.
- The screws of the top / bottom cover of the belt are loose.

If the above problems cannot be resolved, please visit the KYMCO service station for inspection or replacement.



Caution

- Please do not adjust the belt and remove relevant rear wheel mechanisms arbitrarily. They should be repaired by professionals at the KYMCO service station.
- If there are cracks or deformed damages to the top/bottom covers, they should be repaired immediately for safety.



Warning

- Please do not ride the vehicle with the top / bottom belt covers removed.
- Do not insert any tools or bodily parts into the vehicle when the engine is turned on or is moving.
- Do not spray or apply any oil or unknown solvents to the belt to prevent the mutation of the material.
- The passenger shall not use the top cover as the footrest. This may deform the cover and affect the belt.

SIDE STAND

Side Stand situates on the left side of scooter; push the Side Stand down or up with your foot. Engine cannot be started when the Side Stand is pushed down

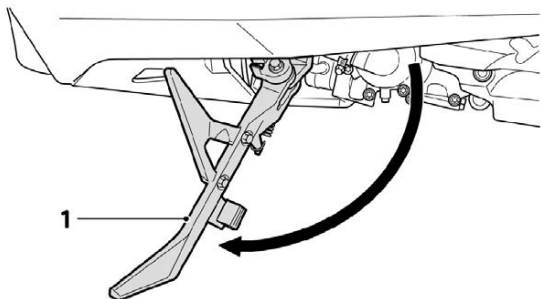

1. Side Stand

Warning

- Side Stand Switch is a part of the ignition obstruction circuit; the rider must push the Side Stand up before riding the vehicle. If this function becomes inactive, go to a KYMCO service station for repair.
- Do NOT ride the vehicle if the Side Stand fails to lower down or maintain the pushed-up position; should the Side Stand touch the ground, the rider may lose control of the vehicle.

Simplified Maintenance and Repair**Regular Checks**

To ensure comfortable riding, regularly checking of your vehicle is necessary. Please go to a KYMCO dealer or service station for after sales service and maintenance. Refer to User Manual for Check Schedule and Check Items.

Regular check is also required when vehicle is left idle for a long period of time.

Initial Check

Please perform the initial check of a new vehicle within 1 month from the date of purchase or at the mileage of 1000km.

Precautions

If a cleaning, adjustment, or replacement is necessary based on the check result, please carry it out as required.

Caution

- Take safety precautions while performing maintenance.
- Brace the vehicle with its main stand on a level location.
 - Operate with proper tools.
 - Carry out preparations with the engine stopped.
 - Engine body and muffler are extremely hot after engine stops, take care not to be burnt.

Overview of Regular Maintenance

I: Inspection; clean, lubricate, replenish, remedy or replace as required. A: Adjustment. C: Cleaning. R: Replace. T: Tightening. M: Maintenance. D: Diagnosis

Random maintenance items

FREQUENCY	WHICHEVER COMES FIRST	ODOMETER READING						
	X 1000 km	1	5	10	15	20	25	30
	X 1000 mi	0.6	3	6	9	12	15	18
ITEM	MONTH	1	6	12	18	24	30	36
Air Filter Servicing				R		R		R
Spark Plug				I		R		I
Throttle Free Play			I	I	I	I	I	I
Valve Clearance	Check/Adjust.	Every 40000 km (24000 mi)						
Hose Inspection				I		I		I
Engine Oil		R	R	R		R		R
Engine Oil Screen		C	C/R	C/R		C/R		C/R
Engine Oil Filter		R		R		R		R
Fuel Injection Diagnostic Tool				I		I		I
CVT Clutch Removal				I		I		I
Brake Fluid			I	R	I	R	I	R
Brake Pad Replacement			I	I	I	I	I	I
Brakes			I	I	I	I	I	I
Switches			I	I	I	I	I	I
Steering			I	I	I	I	I	I
Lights			I	I	I	I	I	I

Simplified Maintenance and Repair

Torque Specifications			I	I	I	I	I	I
Wheels/Tires			I	I	I	I	I	I
Coolant Level Check			I	R	I	R	I	R
Drive Belt (CVT)						R		
Transmission Belt			I	I	I	I	I	I

Remark: If the engine or clutch is replaced, the following item should be recorded from the beginning : engine oil, engine oil screen and engine oil filter.

Check Battery

This vehicle uses maintenance-free battery.
No battery fluid replenishment is required.

Check battery voltage:

Battery voltage shall exceed 12V when checked using a voltmeter. Remove battery and fully recharge it if voltage is too low.

Method of replacement

Disassembly of the battery cover

1. Remove screws to detach the battery cover.



2. Remove the positive/negative pole screws from the battery.



3. Remove Battery

Installation of the battery

Install in the reverse sequence.

**Warning**

- Tenons and grooves are provided on outer covers. To prevent breaking the tenon by pulling or bruising it at portion of an acute angle, you need to be very careful when removing or installing an outer cover. If you worry about breaking the latch, or are not confident with its operations, please allow the KYMCO dealer shop to handle it.

**Caution**

- Please note, before installing the battery cover, attach the positive pole cable to the fixing groove inside the cover. Adjust the cable hole position after replacing the cover, then lock the positive/negative terminals in place. Finally, tighten the battery cover.
- Battery tends to self-discharge and become weak when the vehicle is left idle for a long time. Remove Battery from the vehicle and fully re-charge it; then store it in a cool and well ventilated place.
- Remove the negative cord from the battery if the vehicle is expected to idle for a long time.
- A weakened battery voltage is displayed on the Dashboard; you will need to remove the battery and fully re-charge it, or go to a KYMCO service station for service.
- If battery is stored for more than 2 months, it shall be checked monthly and re-charged if necessary.
- When re-using a stored battery, fully recharge it before installing it.

Cleaning Battery Poles

For cleaning battery poles, remove a battery fixing screw first.

If battery pole is corroded, remove the battery for cleaning.

After cleaning, apply a thin layer of grease or Vaseline on battery poles before installing battery.

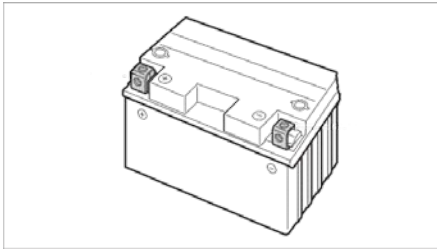

Caution

- Keep away from naked fire when removing/installing a battery.
- For removal, turn KEYLESS Main Switch to OFF position first. Followed by removing the negative (-) wire, then the positive (+) wire. Connect the positive wire first when installing, then the negative.
- Fully tight a slackened nut of battery poles.

Precautions on using batteries:

- Electrolyte in the battery contains sulfuric acid, therefore is toxic and dangerous; severe burn may occur on negligence; avoid getting in contact with skin, eye or clothing. Wear goggles when working in the vicinity of battery. In the event of following conditions, take first aid measures as required:
- Skin contact: Rinse with plenty amount of clean water.
- Ingestion: Drink large amount of water or milk and seek medical care immediately.
- Eye contact: Rinse with clean water for 15 minutes and seek medical care immediately.
- Battery will generate explosive hydrogen, therefore shall be kept away from any fire source (e.g. spark, flame or lit cigarette).
- Provide with sufficient ventilation if charged in an enclosed room.
- Store batteries in a location where children cannot access.
- The battery is located under the front cover. Remove the rear seat cushion and remove the seat cushion cover, and the battery will be exposed. For re-charging the battery: When battery power is about to deplete, immediately go to a KYMCO dealer for re-charge. Keep in mind that the more option devices installed on the vehicle, the faster the battery power depletes.

Fuse Replacement

The fuse is located to the side of the battery. Open the fuse cover to get to the fuse.

- Turn KEYLESS Main Switch off, check for blown Fuse.
- Only replace with a fuse of specified capacity.
- Identify the cause of a blown fuse before replacing it.

Fuses Specification

MAINFUSE : 30A

Fuel Injection Parts : 10A

CONTROLLER : 12A

LIGHTS : 10A

SEAT / HAZARD : 7.5A

Heater Grip / DC SOCKET : 5A

FAN Motor : 10A

ABS Module : 25A



Caution

- Only replace electrical devices (lights, meters) with ones of specified ratings.
- If using an inadequate fuse, it may be blown easily or battery loading may become imbalance.
- Avoid frontal strong water jet when cleaning the vehicle.



Warning

- The use of oversize fuse as replacement is strictly prohibited, as the circuit may overload and burn out.
- The use of non-fuse or short-circuit methods as fuse replacement is strictly prohibited, as this may cause the circuit to burn out or cause fire to the vehicle.

Air Filter

Replace Air Filter Element as specified in Regular Maintenance Schedule.

Check and replace Air Filter Element more frequently if vehicle is often used in dusty environments or damp areas.

Replace Air Filter Element

1. Remove outer covers of vehicle.
2. Remove Air Filter Cover.
3. Loosen Air Filter Cover Fixing Screw and take out Air Filter Element.

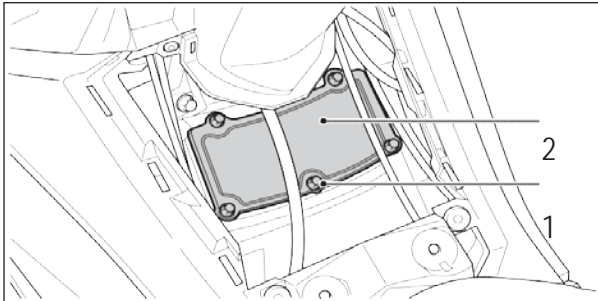

4. Take out Air Filter Element
5. Replace a new Air Filter Element

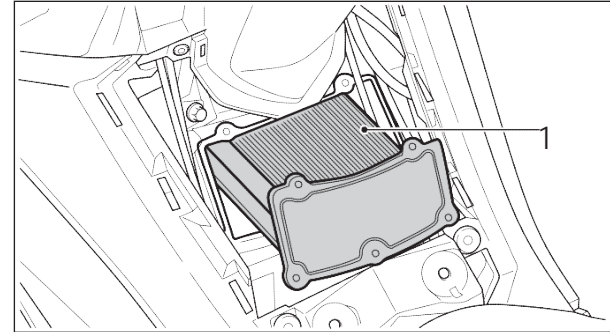

1. Air Filter Element

Precautions on replacing Filter Element:

- Make sure the Air Filter Element is positioned correctly in the case.
 - Do not start engine when Air Filter Element is not installed, or dirty air may enter the engine and cause abnormal wear.
 - Do not wet the Air Filter Element when cleaning the vehicle, or engine start may become difficult.
6. Install Air Filter Cover and tighten Fixing Screw.
 7. Re-install outer covers of vehicle.

NOTE:

Replace with a new Air Filter Element every 10000km.

CVT Transmission System Filter Wool

Excessive dust accumulation in CVT Transmission System may result in unsmooth vehicle operation; clean and replace Filter Wool regularly.

Based on the maintenance cycle indicated in the periodic maintenance schedule, clean the filtering core and then replace the filtering core every 10,000km.

Replace Filter Wool

- 1.Remove side plate on the right.
- 2.Remove Fixing Bolts of Crankcase Right Cover.
- 3.Remove 2 Fixing Bolts of Filter Wool.
- 4.Replace Filter Wool.

Insert Method: Operate in reversed procedures as removal.



Cleaning Method

- 1.Remove side plate on the right.
- 2.Remove Fixing Bolts of Crankcase Right Cover.
- 3.Remove 2 Fixing Bolts of Filter Wool.
- 4.Clean Filter Wool body with air jet and clean out dirt from Crankcase Right Cover.

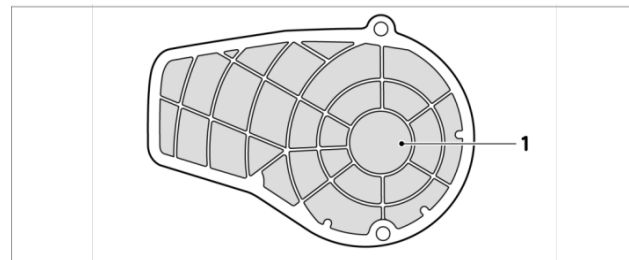

1: Filter Wool Body

User Precautions:

- Do not remove battery cable when KEYLESS Main Switch is set to ON.
- Tighten torque: 0.1~0.2 kgf-m (do not exceed 0.6 kgf-m). Tighten bolts using a maintenance tool; do not tighten it excessively or the bolt may break and cable may get loose, resulting in an accident.
- After installation, make sure that bolts will not slacken and wires will not interfere with chassis, so as to prevent any potential danger.
- When the user or personnel of service station removes the muffler, it is necessary to disconnect O2 sensor connector first.

 **Caution**

When riding or parking vehicle in humid environments (e.g. in a rainy day or washing vehicle), fog formation may occur temporarily inside the cover of Dashboard and lights due to inside/outside temperature differences; which is not a quality issue of them. However if large amount of drops or accumulation of water appears inside Dashboard and light cover, please consult a KYMCO dealer for receiving service.

Change Oil**Oil Change Period**

First oil change when running 1,000km, second oil change when 5,000km and third oil change when 10,000km. Afterwards, change the oil every 10,000km.

In order to maintain optimal engine performance, check oil level every 1,000km. Replenish to standard level in case of shortage.

If engine or clutch is replaced, refer to the Maintenance Schedule for more details.

Oil Capacity:

Dismantle: 3.0L (full capacity)

Change oil: 2.6L (excluding oil filter)

2.7L (including oil filter)

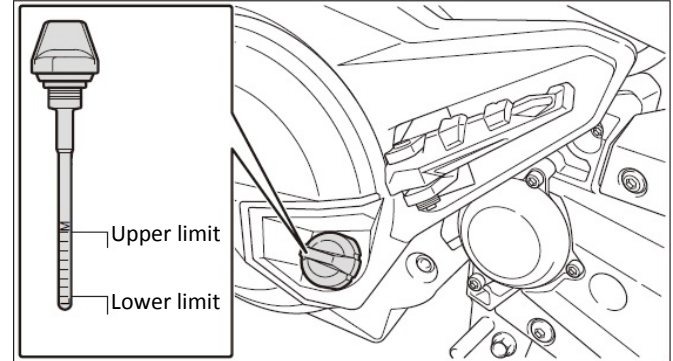

Applicable Temperature of Engine Oil

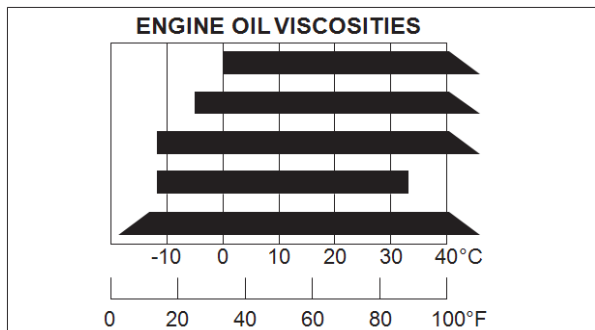

Caution

To avoid using poor quality oil, please go to a KYMCO dealer for oil change.

Oil Change Method

1. Remove Oil Level Guide.
 - ✧ Remove Drain Bolt.
 - ✧ Drain all the oil. Warming up the engine before changing oil facilitates oil draining.
2. Clean Oil Screen and re-install it. Tighten Drain Bolt after wiping it clean.

3. Fill the fresh engine oil and the replenishing volume shall be 2.6L each time (if the engine oil filter is included, then the replenishing volume shall be 2.7L).
4. Fully tighten the Oil Level Guide.
5. After warming up the engine, stop engine and wait for 1 minute; then verify oil level with Oil Level Guide.

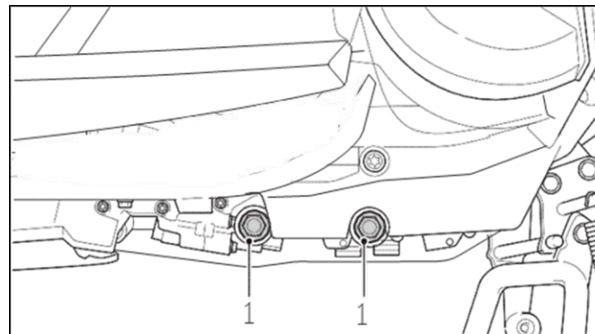

1. Drain Bolt

**Caution**

- It is recommended to use KYMCO original 4-stroke engine oil.
The following conditions may expedite oil deterioration. An early oil change is advised.
 - ◇ Riding on pebbled roads often.
 - ◇ Riding short distances often.
 - ◇ Idling often.
 - ◇ Riding in the cold area.
- When replenishing oil, make sure the oil level is not exceeding the upper limit mark.
- Do not mix-use oils of different brand, class or low quality ones; they may cause engine faults.
- Change oil while the engine is still hot; be careful not to burn your skin.

Oil Filter Element Tightening Torque:

11 N-m (110 kgf-cm)

Engine oil discharge bolt tightening torque:

9 N-m (90 kgf-cm)

Magnet Screw Tightening Torque:

28 N-m (280 kgf-cm)

Precautions on Oil Change

- Excessive and insufficient oil amount can both affect engine performance.
- Excessive Oil - Increased friction resistance of moving parts in the engine, which lowers output power and increases engine temperature, leading to early deterioration of engine oil.
- Insufficient Oil - Reduced oil supply to moving parts in the engine, therefore results in worn parts, parts ablation, etc.
- Do not mix-use oils of different brand, class or low quality ones; they may cause engine faults.
- Kymco Emissary Engine Oil contains additives (e.g. spirits, etc.) during the manufacturing process.
- Arbitrarily mixing additives bought from the market may deteriorate the oil, affect lubricating properties and shorten the service life of engine.

Spark Plug Check and Adjustment

Dirty electrode or excessive gap can cause poor sparking.

Cleaning Method

Use a Spark Plug Cleaning Device is the best way if a Spark Plug Cleaning Device is not available, clean with a needle brush.

Adjustment

Normal Gap of Spark Plug is 0.7-0.8mm (See the Figure).
Do not use a Spark Plug other than the specified one.

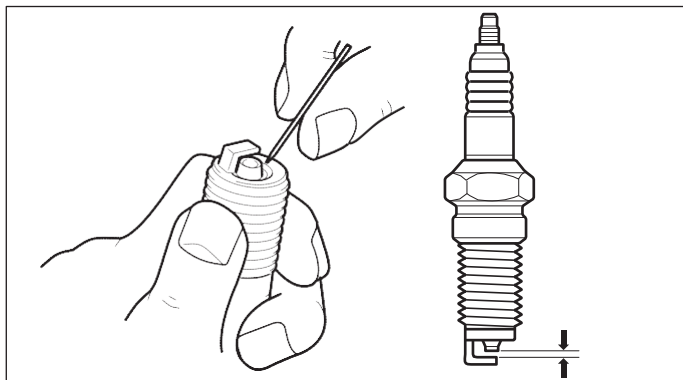

Specified Spark Plug:
(NGK) CR7E



Caution

- Engine is very hot after stopping, be careful not to get burnt.
- Tighten the plug by hand, followed by using a Spark Plug Spanner.

Tightening Torque:
100-140 kgf-cm

Check Coolant

For the sake of safety, check level of coolant before riding the vehicle. Replace the coolant as specified in Regular Maintenance Schedule.

Check Level of Coolant

1. Park the vehicle on flat ground and brace it up with Main Stand.



Caution

- Temperature in the engine may cause false reading of Coolant level. Check coolant level after the engine cools down.
- Inclined vehicle may cause false reading of Coolant level.

2. Check level of Coolant via viewing window on the preserving radiator. Make sure the level is between "F" and "L" marks.

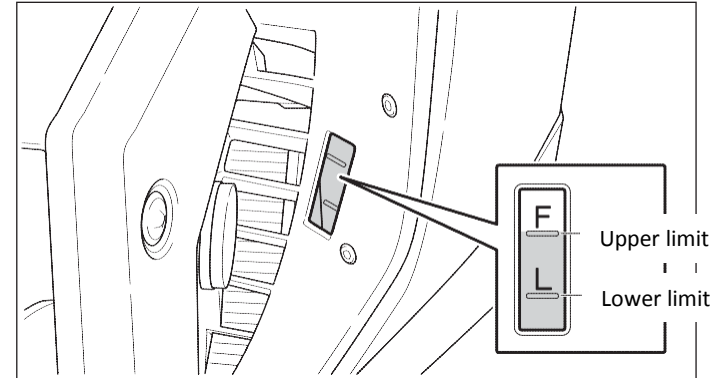

Caution

- Before riding the vehicle, check the radiator and piping for any leakage.
- Check the ground where the vehicle is parked for any leakage mark.
- Before riding the vehicle, check the fin and front protection screen of radiator for any foreign object. Foreign objects may reduce the cooling function or even cause vehicle or engine damage in worse conditions.

Replenish Coolant (Fill the Reserve Radiator)

1. Stand the vehicle upright on flat ground.
2. Open Reserve Radiator (remove screw 1 and cover 2), replenish water to Upper Limit. If level of coolant gets excessively low, something must be wrong.

Go to a KYMCO Dealer for check and repair.

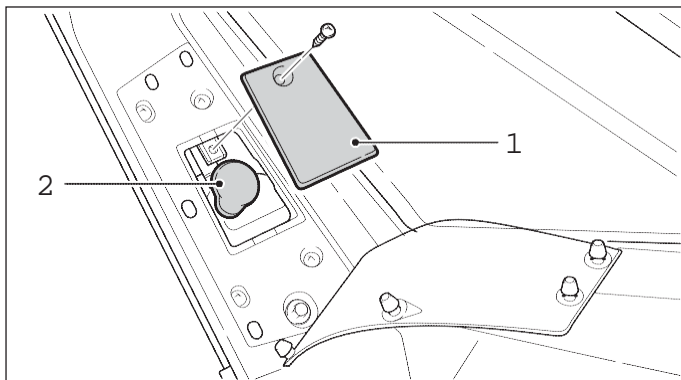

1: Protection cover 2: Water tank cover



Caution

- Water temperature is very high after riding, do not open the cap of radiator.
- Use soft water for mixing cooling liquid.
- Using poor quality coolant may shorten the service life of radiator. Please be careful.
- Replace coolant in the radiator every 10000km.
- Add proper amount of radiator additives to ensure performance of the cooling system.



Warning

- If the vehicle is being used in freezing or frozen environments, coolants with anti-freezing properties must be used to prevent damage to the coolant system due to freezing.

In case of fault of vehicle:

Go to a KYMCO dealer for check and repair if any fault occurs when riding the vehicle. Use only original parts for replacement.

Check following items if engine does not start or engine stops when riding the vehicle:

- Whether gasoline is sufficient.
- Whether Dashboard Fuel Indicator approaches E. Replenish with 95 unleaded gasoline or better.
- Whether proper method is used for starting the engine.
- Others, whether any part is faulty.
- Whether the engine shut-off switch is in the correct position.

MEMO

Introduction and maintenance to the environmental mechanism

Introduction to the exhaust emission control system

Exhaust Emission Control System:

The exhaust emission control device of this model of the vehicle uses the fuel injection system to control the emission pollution effectively. Then, through the ternary catalyst converter in the exhaust system, the pollutants are transformed again, to achieve the result of ultra-low exhaust pollution.

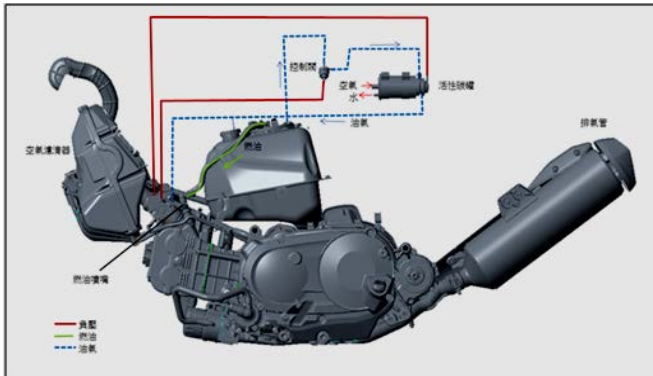

Warning

The exhaust pipe is extremely hot. The vehicle must be parked in places where passersby and children cannot touch arbitrarily.

Caution

- Ensure that the exhaust emission control system functions normally, please inspect and maintain your vehicle on a regular basis.
- Ensure that the exhaust emission control system performs normally, please do not modify the vehicle arbitrarily so that the exhaust emission pollution will not be affected and incur fines.
- If there are questions, please consult the Company's dealer shops or do inspections at scooter exhaust inspection and repairs stations recognized by the Environmental Protection Administration.

Maintenance for the exhaust emissions control system

Method of operation:

























- For replacement of the filter for the air filter, please refer to method of operation for “air filter”.
- Engine oil: For better lubrication performance and smoother movements of the engine, please change the oil at 1000 km for a new vehicle, then every 5000 km afterwards.
- Gasoline: To prevent the performance of the ignition system from affecting the combustion efficiency, 92 unleaded gasoline or above must be used. The use of leaded gasoline is strictly prohibited. (Using leaded gasoline may lead to the premature aging and failure of the catalyst converter inside the exhaust pipe)
- For standard values of relevant exhaust tests for injection-type exhaust concentrations, please visit the exhaust testing station or inspection station for adjustments or repairs.

Introduction to evaporative emission control system (E.E.C)

The E.E.C device is used to collect the evaporated oil and gas from the gas tank and the throttle valve, to prevent the oil and gas from being released into the atmosphere and cause environmental and air pollution.

Inspection of evaporative emission control system (E.E.C)

- The emissions value of said vehicle model comply with the 7th-phase regulation standards. Please do not arbitrarily adjust the settings of the parameters.
- Please do not remove or modify the vacuumed tube of the E.E.C device.
- To reduce emission pollution, when the vehicle is idle, do not turn the throttle handle repeatedly.
- Aside from regular maintenance, if visible abnormalities are found (such as poor ignition, emission of black smoke), visit the Company's dealer for inspection or repairs immediately.
- Only use 92 unleaded gasoline or above to ensure the normal functioning of the pollution prevention parts.
- Please refer to the items list of exhaust emission control system maintenance for maintenance.

	Keyless	Noodoe	TPMS
Manufacturer	Fames Technology Co., Ltd	Kwang Yang Motor Co., Ltd	Lihjoen Speed Meter Co., Ltd
CE	report 	report 	report 
FCC	in procedure	 2AM4E-37130-LGC6	 2AMA5-LJ-39600
JRF	Receiver:   201-17826	  005-101624	  021-170813
	Control:   201-17827		
KCC	Receiver:  MSIP-CMM-fms-38700-LGC6-00	 MSIP-CMM-KYm-37130-LGC6	Receiver:  MSIP-CRM-LIJ-39660-LGC6-00
	Control:  MSIP-CMM-fms-38703-LGC6-00		Control:  MSIP-REM-LIJ-39650-LGC6-E00
NCC	Receiver:  CCAL17LP0150T9	 CCAN17LP0260T0	Receiver:  CCAL17LP0150T9
	Control:  CCAL17LP0140T6		Control:  CCAL17LP0140T6
	NFC:  CCAB17LP0540T0		
SRRC	Receiver: CMIIT ID: 2017DJ4315	CMIIT ID: 2017DJ4304	
	Control: CMIIT ID: 2017DJ4313		

Specifications

AK550 Premium E5 - SBA1BA

Item	Specifications	Item	Specifications
Engine Type	SBA1	Total Length	2190 mm
Displacement	550.4 c.c.	Total Width	790 mm
Cylinder diameter × Stroke	69*73.6	Total Height	1480 mm
Compression Ratio	11	Axle Base	1580 mm
Gear Shifting Method	CVT	Vehicle weight (working mass)	239 kg
Clutch	Wet Centrifugal Type	Front Tire	120/70- R15
Ignition Method	ECU Full Transistor Type	Rear Tire	160/60-R15
Starting Method	Self Start	Minimum revolving radius	2700 mm
Total Oil Content	3.0L		
Fuel type	95 unleaded gasoline or better		
Battery Capacity	12V 11.8Ah		
Spark Plug	NGK CR7E		

AK550 Premium E5 User Manual
KWANG YANG MOTOR CO., LTD.
Second Edition – 2023 January
Copyright © Do Not Copy
Printed in Taiwan
T300-SBA1BA-A1

MODENAS

Motosikal Dan Enjin Nasional

MOTOSIKAL DAN ENJIN NASIONAL SDN. BHD. 199501025408 (354613-V)

Kawasan Perindustrian Gurun,
08300 Gurun, Kedah Darul Aman, Malaysia.

T +604 466 8000 | F +604 466 8300

EMOS Edaran Modenas Sdn. Bhd. The Distribution Arm of MODENAS

WHATSAPP
TALIAN KHIDMAT PELANGGAN
+6019 - 570 8135

PUSAT PANGGILAN PELANGGAN
1 800 880 181

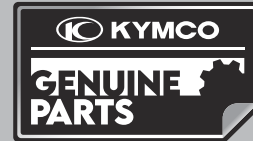

Abdi Kumpulan

DRB-HICOM